



ORIGINAL HEIDELBERG

Hints for the Pressman

A SUMMARY OF PRINTING SUGGESTIONS
FROM PRESSMEN TO PRESSMEN

**Dedicated
to Pressmen Operating
Original Heidelberg**



At the time this book was printed, more than 80,000 Heidelberg presses had been shipped to all parts of the world. This book is dedicated to pressmen operating these machines. We hope it will serve as a source of reference and information, and that our hints and suggestions will be helpful to pressmen in their daily work.

This book is published in more than 15 languages, and is intended not only for press personnel in a large plant, but also for those pressmen and owners in remote, small shops who cannot readily obtain inks, printing plates, stock, and the necessary printing aids in the quality available in metropolitan areas. Since the book is published for a diversified and world-wide group of printers, some of our suggestions and perhaps some of the terminology will not be applicable to every reader. However, we feel that there is something of interest for all pressmen in this book. No one in our industry becomes completely skilled only through his own experience. Skill in press work is developed by learning basic techniques on simple jobs, then as skill increases, progressing to more complex work.

A good pressman remains a student and observer throughout his career. "Shop talk", attendance at craftsmen club meetings, reading and observing, are all necessary parts of learning.

With this book you will truly "share your knowledge" on a universal basis. The data contained herein is taken from our study of Heidelberg printing techniques throughout the entire world.

We hope that the information we have compiled in this book will be adapted to solve some of your own particular problems.

We would like to add that this book is not intended to supplant the Heidelberg Operation Manual, nor is it designed to serve as a general instruction book for printing. At the back of the book you will find a comprehensive index to help you find information quickly.

Hints for the Pressman is edited and published by the Advertising Department of Schnellpressenfabrik AG Heidelberg in connection with its after-sales service program. This book was printed on Original Heidelberg at the firm Schanze/Kassel, a printing establishment operating with 18 Original Heidelberg Cylinders and 11 Original Heidelberg Platen Presses. Most of the articles are extracts from past issues of our house organ Heidelberg News which is published bi-monthly. We suggest that you refer to current issues of Heidelberg News for additional "Hints for the Pressman".

Published by the Advertising Department of Schnellpressenfabrik AG Heidelberg . Printed on 21 x 28" Original Heidelberg Cylinders . Reproduction of any contents is permitted, provided source is stated . Printed in Westgermany 1957

CONTENTS

Platen Press Printing:

Packing and makeready for printing mixed forms (halftones and type matter)	8
Printing halftones	9
Printing solids	12
Printing of process color work	13
Profitable die-cutting	15
Embossing and impressional strength	18
Profitable embossing	19
Carbon printing and the ink fountain heating device	22
Numbering	24
Slurs in platen press printing	25
Check your knowledge on printing techniques	27
Ghosting (repeats)	28

Cylinder Press Printing:

Process color printing	30
Die-cutting	33
Numbering	36
Profitable embossing	38

Carbon ink printing with ink fountain heating device	40
Requisites for obtaining quality prints on Original Heidelberg Cylinders	41
Slurs in cylinder printing	43

General Section:

Tympan sheets for Original Heidelberg	48
Check your knowledge in printing techniques	51
Leveling-up and spot work	52
Mechanical chalk relief makeready system	54
Primaton makeready system	55
Gold ink printing	56
Gloss printing inks and high gloss stock	57
The use and care of rubber rollers	58
The practical use of the speedy form positioner	59
Pressroom safety	61
The blind printing line	62
Kastoline	63
Off-set	63
Color refusing to take	63
Packing - thickness of packing	64
Composition of packing	65
Automatic throw-off	66
Printing aids	66
Printing two-up	67
Something is wrong here	67
Thin stock	68
Mottling, picking, roller marks, slipping of rollers, and slur when ink is too tacky	69
Solution to "Quiz"	72
Static electricity	75
Extra accessories for specialty work	76
Device for pre-registering forms on the Original Heidelberg Cylinder	79
Index	80
Illustrations showing the Original Heidelberg	82
Adresses of distributors and dealers	88

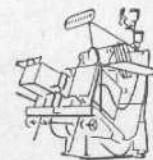

**FOR THE PRESSMAN OPERATING
ORIGINAL HEIDELBERG PLATEN PRESSES**

PACKING AND MAKEREADY

FOR PRINTING MIXED FORMS (HALFTONES AND TYPE MATTER)
ON HEIDELBERG PLATENS

On mixed forms, a thin rubber blanket is used for the halftone areas, and a sheet of ivory-finished cardboard for the type areas. Both rubber blanket and cardboard are pasted over the makeready on the tight sheet under the top sheet. Make sure that the thickness of overall packing is the prescribed $\frac{1}{25}$ ".

Pull an impression on the tight sheet which has been pasted to the bottom edge of the platen and secured by the tympan rods at bottom and top. This will give you the exact position for makeready. Use tissue or folio behind the form if the printed sheet shows uneven areas caused by old type. This is then followed by a hand cut overlay (see page 52), a mechanical chalk overlay makeready, or a Primaton makeready. Detailed explanations about these makeready systems are found on page 54-55.

The makeready which has been pointed at all four corners before etching or has been provided with small pointed cuts, is then pasted on the tight sheet. Temporarily, a cover sheet is stretched across this makeready. As the packing becomes thicker from spotting and addition of cover sheet, several of the fill-in sheets must be removed from the packing. The cut-out pieces of rubber

blanket and the ivory finished cardboard are then placed upon the makeready so that they are below the temporary top sheet.

The pressman now pulls an impression to determine if further makeready is required. If any areas still lack good impression, correct them by using tissue paper on the tight sheet underneath the rubber blanket.

When makeready is complete and the entire form (halftone and type matter) prints evenly, remove the temporary cover sheet and replace it with a tympan sheet. The tympan should be clamped at all four sides and must remain absolutely smooth.

Use of a good tympan is important. Always keep on hand a supply of pre-cut tympan sheets prescribed for the Original Heidelberg. Your dealer can always advise you where to procure these if your own paper supplier does not carry them.

For long runs, it is advisable to slightly moisten the top sheet on both sides with a sponge before placing and clamping it on the platen. As it begins to dry, it shrinks and becomes taut. It will remain smooth and tight for several days' running. Always remember that a creased or wrinkled tympan can cause poor register, and that loose packing may cause slurring.

PRINTING HALFTONES ON HEIDELBERG PLATEN PRESSES



Fastening of Plates

When printing on a platen press, the cut must be brought to exact type height (ill.1). Large plates should be mounted on a metal base with the use of good adhesives available today. Such mountings can be easily stripped by heating them with an electric heater.

Packing

When printing halftones, the packing of the platen is of major importance. In our experience, we have found it best to paste one sheet of manila tympan paper at its lower edge to the bottom edge of the platen and then clamp it in with the tympan bar. Later, makeready is pasted on this sheet. Between this sheet and the platen surface, several sheets of pressboard and MF paper are inserted until the thickness of the packing is brought up to $\frac{1}{25}$ " (ill.2). (Our Operation Manual will show you specimen packings.)

Leveling

If the form contains large halftones, a spot sheet should be made before preparing the handcut or mechanical makeready. To do

this, pull an impression on a sheet of book paper. The sheet is then placed (printed side up) on a sheet of carbon paper. The areas to be made ready are then marked out (ill.3). If there are any unusually large or solid areas, it will be necessary to spot them with two or three layers of tissue. It is always best to have cuts mounted on metal. However, if a cut is wood mounted, we recommend that you use a two- or three-ply underlay or interlay. This will better counteract a wood mounted plate's tendency to give. The packing should be reduced to the prescribed $\frac{1}{25}$ " by removing some of the pressboard or book paper.

Makeready

When the cuts print evenly, the mechanical makeready can be prepared. Solid areas require more impression than highlights. All makeready systems are based upon this principle.

Hand Cut Makeready

First, pull an impression on four sheets of MF newsprint. On sheet No.1 cut out the solid



②



③



④

areas and paste the cut-outs on sheet No. 4. On sheet No. 2, the solid areas and the middle-tones are cut out and pasted on sheet No. 4. On sheet No. 3, only the highlights are cut out and then the remainder of this sheet is pasted on sheet No. 4. Thus, all the solids have four thicknesses of MF paper, the middle-tones have three, and the highlights have only one thickness, the latter being the fourth sheet upon which the hand cut-outs were pasted. To obtain finer tone values, use tissue paper. (See page 52.)

MKZ (Mechanical Chalk Overlay Makeready) and Primaton

(A detailed description of these two systems will be found in our Operation Manual and on page 54-55 of this book.)

When pulling the impressions for either of the above mechanical makeready systems, use a little more impression by inserting a sheet of the stock to be run into the packing. (Do not forget to remove this sheet from the packing afterward). Run the sheet through the machine twice with hairline register. After further processing, the mechanical makeready is pasted directly on the spot sheet.

Inks for Printing Halftones

For good halftone work, use only quality inks recommended for this type of work. Check to see that they are suitable for the stock you are running. Good halftones cannot be produced by using job inks. To get good illustrations on platen presses, the inks must be stiffer and more full-bodied than those required for cylinder press printing.

When ordering inks, specify that they will be used for platen printing. You are then certain that the ink will be of good quality and of the right consistency. Platen ink is rich in pigment and stiff. It will flow smoothly and when taken up on the ink knife, it will break off short.

If the paper tends to "pick", it is necessary to dope the ink to suit the stock. In this case, the ink is made softer by using reducers. Use these carefully, for if the reducing is excessive, there is a possibility of the ink becoming greasy and rubbing off even months after printing.

In some regions special platen press inks may not be readily available. In this case, we recommend the following:

If the ink is gray and mottled, it proves that the ink is weak in pigment. This type of ink



⑤



⑥



⑦

may be suitable for cylinder printing, but because of the different method of impression, it will not work on platens. Inks that tend to mottle can be improved by adding a small amount of powdered rice flour or cornstarch. This will give the ink more consistency. Sometimes the addition of a black offset ink will help. If an ink tends to be tacky so as to result in "picking", add 2 to 3% of ink paste.

If a sheet sticks to the form, it is a sign that the ink is too long. The remedy is to reduce the ink as mentioned above or to mix it with an ink of the same color but of a thinner

consistency. For example, a bond ink could be reduced with a job or halftone ink.

Setting of Rollers

Remember, too, that roller settings must be checked with a typehigh gauge. If the roller tracks are adjusted too low, slurring will result and the screen of the halftone will fill in. We always use top grade rubber rollers when printing halftones. It is important that they be cast to the correct diameter prescribed for Heidelberg presses. One final reminder . . . make sure that the roller tracks and roller trucks are free from grease and oil.

PRINTING SOLIDS

ON HEIDELBERG PLATEN PRESSES

When printing solids on platens, remember that the entire form is printed at one time and the sheet must be taken off the form in one movement. In cylinder printing, the sheet is rolled over the form by the cylinder and only a portion of the cylinder contacts the form at any one time. Hence, the reason why platen inks differ from cylinder inks. Inks for platen printing must always be as heavy bodied as possible.

If the paper tends to pick, it is necessary to dope the ink to suit the stock. In this case, the ink is made softer by using reducers. However, if reducing is excessive, there is a possibility of the ink becoming greasy and rubbing off even months after printing. To avoid this trouble and give a more solid consistency to the ink, add a small quantity of cornstarch. This will keep the ink short and prevent the paper from sticking to the form. Whenever driers are necessary, they should be added in proportions recommended by the ink manufacturer.

If ink cannot be used directly from the can, the added printing aids should be mixed in thoroughly. The best way to do this is on stone or glass. Another big factor in producing good solids is the correct composition of the packing. For this we recommend use of a rubber blanket. Place it between the top sheet and the spot sheet, making certain that it covers the entire area of the solid.

Better inking on large solids can be obtained through use of rider rollers. One is available for the 10x15 Original Heidelberg while two can be used on the 12x18 Original Heidelberg. Always make certain that the roller tracks and roller trucks are free of grease



or oil. Powdered rosin dusted on the roller tracks will insure good friction. Observing these few simple hints will result in much better production of solids. Thousands of printshops all over the world will attest to the Original Heidelberg's efficiency in this type of work. (Also refer to pages 69-72)

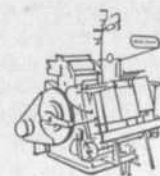

PROCESS COLOR WORK ON HEIDELBERG PLATEN PRESSES

The basic elements for good process color work on Heidelbergs are the same as for any other press. It requires good plates, paper, ink, and the know-how of an experienced pressman, one who is adept in making ready and has a "touch" for matching inks.

The packing used is the same as for halftone work. The hanger sheet for makeready is clamped together with the tympan to the bottom clamp. Depending on their thickness, insert about 7 to 9 drawsheets between the hanger and the platen. Place a rubber blanket over these inserts. If a larger printing area is involved, substitute a sheet of blotting paper for 3 of the drawsheets and place it on the bare platen. Be sure that the correct packing thickness is always maintained.

Best results are obtained using 11 point plates and patent base. Registering is simplified by the use of hooks, eliminating the unlocking of the form. This is especially true when there is a number of plates in the same form. The use of sticky-back tape for mounting plates is recommended.

The use of hand cut or mechanical overlays depends a great deal upon the job to be printed. Areas which do not print evenly after makeready has been inserted are leveled up with thin tissue. After the pressman is sure the form prints cleanly, a rubber blanket is placed over the makeready. For long runs, it is advisable to clamp the top sheet on all four sides of the platen and to dampen the top sheet with a

sponge. As the sheet dries, it becomes taut and gives a fine surface for good impression during the entire run. In order to facilitate positioning of the three remaining colors, the bottom guides and the side guide are set midway in their adjustment spans. By doing this, slight register corrections can be made later. Make sure that the guides are secured tightly to prevent movement while printing. From experience we have gained through many years of producing process color work, we have found that the sequence of blue-yellow-red-black works best in most cases. On some specific jobs, we have also found that the sequence of black-yellow-red-blue produces good results. When printing blue as the first color, an even tone is obtained throughout the entire run, while difficulties may be encountered when yellow is printed first. Since very highly transparent yellow is obtainable, it can be run as a second color without affecting the first. The sequence of printing black-yellow-red-blue is usually followed on those jobs where the black form determines the position and where the black does not particularly stand out. If a pressman has to work without progressives, the best sequence to follow is black-yellow-red-blue. This enables him to use blue in correcting any color deviations which might possibly occur while printing the first three colors.

Driers should be used with caution. Use only a base drier, if needed, on the first three colors; otherwise the fourth color may not

print properly from crystallization of previous colors. A surface drier or a 50-50 mixture of both driers should only be used with the last color, if desirable. Be sure that the sheets do not stick together. Limit delivery piles to about 500 or 600 sheets for best results. A lot of pressmen use a cardboard on the delivery

table so small lifts may be removed with less chance of offset or smearing. Use only a fine anti-offset spray on the first colors to prevent the surface of the paper from becoming too rough. Excessive spray powder will make it difficult to print succeeding colors.

A SUMMARY OF THE MOST IMPORTANT POINTS TO BE CONSIDERED WHEN PRINTING PROCESS COLOR WORK

1. Use only satin-enamelled finished stock or coated paper.
2. The plates should either have a 120 or a 133 screen. The smoother the surface of the paper, the finer the screen can be.
3. For runs over 100,000 use copper plates, for smaller runs zinc or electros can be used.
4. Use process inks. These inks are highly transparent and non-fading. If possible, always use the same inks used by the engraver for sample proofs and progressives.
5. Do not position the second, third, or fourth plates according to the edges of the picture, but choose striking areas in the middle of the subject where the halftone dots fall in exact position.
6. In case the paper storage room and the pressroom do not have the same temperature and humidity, it is advisable to store the stock in the pressroom a few days prior to printing.
7. Temperature and humidity in the pressroom should be constant to prevent the paper from shrinking or stretching, which could cause differences in register. The best atmospheric condition is a temperature 70-80° Fahrenheit with 50-60% humidity.
8. Process inks can usually be used straight out of the can. Doctoring will often dilute the ink and reduce its brilliancy.
9. Use only varnishes, pastes, or driers recommended by ink manufacturers.
10. Make sure that the color plates print evenly before applying makeready.
11. When pulling an impression on the mechanical relief overlay, increase impression strength slightly and let the sheet run through the machine twice in hairline register. Then decrease impression strength.
12. On each stack of printed sheets, place about 20 spoils to prevent the top sheets from warping.

PROFITABLE DIE-CUTTING ON ORIGINAL HEIDELBERG PLATENS

The speedy Original Heidelberg presses have a tremendous advantage when it comes to die-cutting. The fact that it takes so little time to make a Heidelberg ready means more profit to the printer and speedier service to customers.

Original Heidelberg presses have built-in features needed for profitable die-cutting:

- Tremendous speed
- Enormous impression strength
- Simplicity of operation
- Hairline register.

These features give the Original Heidelberg an almost unlimited range of utility. In the field of die-cutting alone, there is a lot of sales potential in every community. A few common die-cutting jobs are folding cartons, tags, labels, inserts, index cards, calendar backs, and advertising cut-outs.

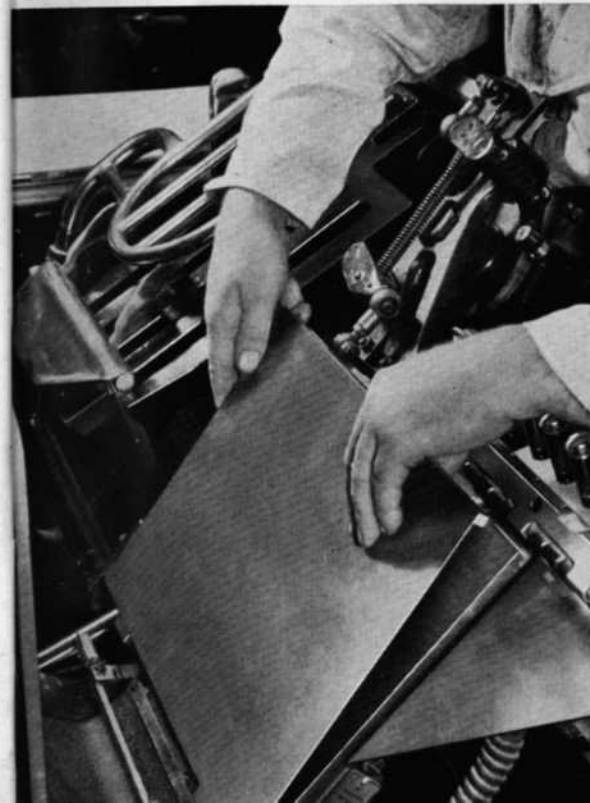

To die-cut on an Original Heidelberg, follow these steps:

1. Remove form rollers from the machine.
2. Place a die-cutting plate on the platen instead of the packing.
3. Nick the cutting rules to prevent the sheet from falling apart.
4. Glue rubber ejectors in various spots on both sides of the rule to prevent stock from sticking to the cutting rules.

We should like to emphasize that it is no more difficult to die-cut on Original Heidelberg than it is to do job work. Simple types of dies which require straight rules mainly (as for folding cartons) can be made by the printer himself, using cutting rules generally available in standard sizes. In addition to straight cutting rules, he'll find that round and curved shapes are also available. Difficult dies must be made to order. Firms making such dies may be found in every large city.

Form rollers are removed when die-cutting to prevent them from being slashed by the cutting rules. On the platen, the packing and the three rods which secure the packing are removed.

Makeready is pasted under the die-cutting plate. The plate is snapped on. With its lugs it rests against the top and bottom edges of the platen. To facilitate snapping on the die-cutting plate, the platen should be opened as wide as possible. If further makeready is required, the plate can be taken off at any time. If register guides are used, make sure they do not hit the lugs.

At the top of the die-cutting plate you will find a small screw for securing the plate. Tighten this slightly with a screwdriver.

The die-cutting plate is quite hard. This means that long runs can be die-cut without the rules cutting into the plate.

We recommend die-cutting plates handled by your Heidelberg dealer. If feasible, have his service department fit the plate to your press. This will insure quick getaway and a trouble-free operation when die-cutting.

If the die is also to contain creasing rules, paste a sheet of tympan paper on the die-cutting plate so that the creasing rule can be made ready. To check the position for makeready, dab a little ink on the rules and then pull an impression.

Before ordering a custom-made die, check to see whether the job can be run in multiples. A cutting rule requires 220 pounds pressure per linear inch of rule when die-cutting cardboard of from .012" to .016" thickness. Scoring and creasing rules require 137.5 pounds pressure per linear inch rule.

Since pressure must be taken into consideration, limit the amount of rule on a 10x15 Original Heidelberg to 197 linear inches and 394 linear inches on the 12x18 Original Heidelberg.

We have repeatedly found that one of the main causes for inefficient die-cutting is the use of dull cutting rules. Specialty shops which do die-cutting on a regular basis need not be reminded of this fault, but those printers who die-cut only occasionally must pay special attention to this matter. It is also important that printers check to see that a die-cutting job does not exceed the maximum load of the press. Many times dull cutting rules, or two sheets of stock sticking and being fed into the press together will cause an overload.

The stock should be carefully fanned and jogged.

Scoring

Scoring on a particular job is necessary when the fold has to be exact, or when the fold runs across the grain of the sheet. Scoring on a platen press is best done with rounded steel rule which is available at most type houses and printers supply firms. It is type high and approximately two points thick. It may be inserted into a form so that the scoring and die-cutting are done simultaneously. Scoring and printing in one operation is also possible but due to the complicated makeready necessary, it is generally preferred to do blind scoring separately.

In preparing a form to be used only for scoring, the rules should be supported on each side by a piece of furniture sturdy enough to keep the scoring rule from bending under pressure.

To make ready a single rule scoring form, a soft packing is generally used so that an even impression is obtained all along the length of the rule. Too hard a packing or too much impression will cut into the stock or will weaken it so that it comes apart at the score when folded.

Some paper stocks do not lend themselves to folding even when the job is scored. Be certain that this is checked before considering a given stock.

Pressmen will find the 10x15 or 12x18 Original Heidelberg with the single-lever variable impression control ideally suited for die-cutting and perforating.

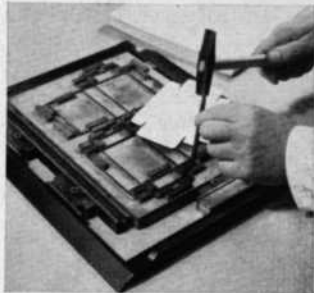

Tiny nicks in the cutting rule prevent the cut-outs from sticking to the form, or dropping down into the machine.



Makeready is pasted under the die-cutting plate.



After snapping the die-cutting plate onto the platen, the plate is secured by tightening the small screw.

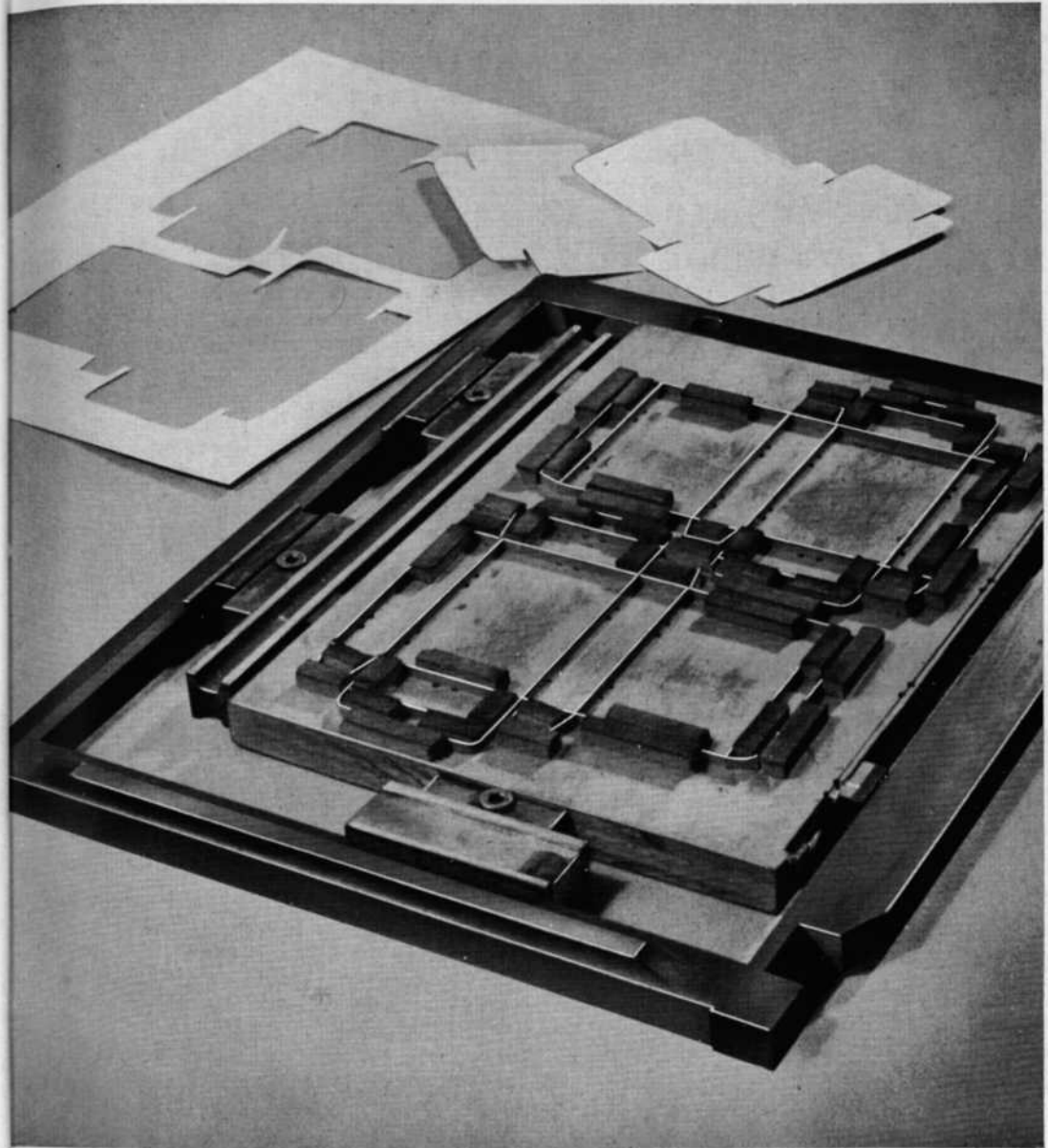

You can print, emboss, score, perforate and number on Original Heidelbergs. Original Heidelbergs mean versatility. Versatility means greater profits.



EMBOSSING AND IMPRESSIONAL STRENGTH

The suitability of Original Heidelberg for the economic production of embossing enables the printer to accept even a wider range of work. Of course, the chief prerequisite for satisfactory embossing is sufficient impression. The toggle lever drive of Original Heidelberg, similar to that used on heavy embossing machines, will meet this requirement. Forty tons impression on the 10x15 Original Heidelberg and sixty tons on the 12x18 are adequate for heavy embossing. Job work, which for many firms is the most important and profitable, offers numerous possibilities for embossing. If a plant or printer is in a position to produce embossing promptly and satisfactorily without necessitating the purchase of expensive single-purpose equipment, suggestions can be made to the customer for making his printed matter still more attractive. A blind embossing on a letterhead or business cards, and colored embossing on small folders very often give this printed matter a completely new and attractive appearance. Most customers will be happy to pay the slight extra charge in order to enhance the appeal of advertising pieces.

In the past, embossing was considered a special operation . . . one seldom undertaken by job printers. However, Heidelberg owners have added both prestige and extra profits to their shops through embossing.

The speed alone with which embossing can be done on Original Heidelberg greatly exceeds that of so-called "heavy duty" embossing platens. In many cases the latter are still handfed. Less time is required for positioning on Original Heidelberg, and the changeover from printing to embossing requires only a few simple moves.

PROFITABLE **EMBOSSING** ON ORIGINAL HEIDELBERG PLATEN PRESSES



First of all, the Female Die

Embossing requires a female die. This consists of a metal plate into which the design or the text to be embossed has been engraved in intaglio. For very long runs, the die must be of steel, but usually it is made of brass averaging 16 to 18 points in thickness. The die is brought up to type high by means of lead or iron backing to which the die is either screwed or glued.

Next, the male embossing die is prepared. This has the same contours as the female die, which must fit into the engraved portion of the female die. To obtain the best results, the male die must include all the details engraved into the female die. The first step in preparing a male die is to clean all oil and grease film from the platen. (Most shops use a cleaning solvent; however, one of our favorite tricks is to rub the platen with an onion.) Next, paste a sheet of mat board a little larger in size than the female die on the platen. Before pasting the counter, moisten it slightly with a sponge to make sure that

it adheres securely. After the counter has thoroughly dried, insert the locked-up female die in the press. The female die should now be inked a little in order to pull an impression on the counter. Since the counter does not have the required packing thickness, it will be necessary to place a few sheets behind the female die in the chase in order to make an impression on the counter. Now pull an impression so that an image of the female die appears on the mat board which was pasted to the platen. This is necessary for preparation and exact positioning of the male die. Having done this, remove the sheet from behind the female die.

Although there are many ways to prepare a male embossing die, printers usually prefer the following method when there is not time enough to allow an embossing compound to dry.

After an impression of the female die is pulled on the mat board, a hard piece of blotting paper (.028" thick) is run through the

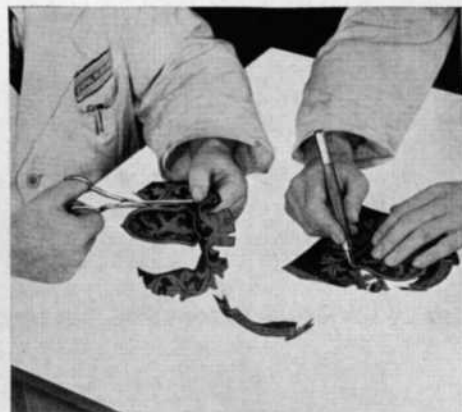
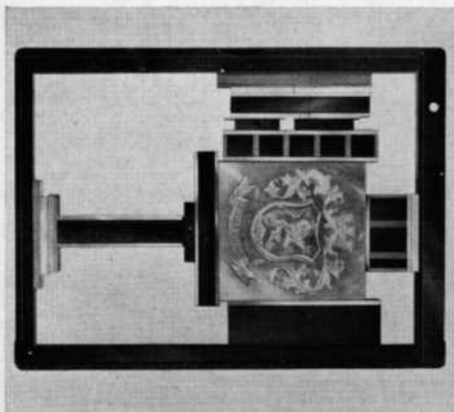

press with impression so that the image is imprinted on it. The intaglio portions of the female die, which do not print on the blotter, must be cut out. Cut these very accurately and paste them in their corresponding positions on the image which appears on the mat board. This serves the purpose of building up the male die. Use a good adherent paste or glue when pasting these blotter cut-outs.

Now take out the form rollers and wash the form. Start the machine, using light impression

at first, then increasing it until the male die is completely formed.

If the details of the male die are not sharp enough, paste an additional blotter cut-out on top of it. To prevent the edges of the female die from marking the stock, make the second blotter cut-outs smaller than the actual size of the female die, but large enough to cover all intaglio parts. Make one more impression with full impression strength so that the intaglio parts press sufficiently into the female die.



In case there are small areas which have not satisfactorily embossed, use tissue paper, pasted on the appropriate areas, for leveling out.

Another Method

The second method requires somewhat more time and should be used in such cases where the male die has very many fine details which cannot be cut out with blotting paper. First mix two parts plaster of Paris with three parts calcium carbonate and add enough dextrin or gum arabic to make a doughy paste. This dough compound is spread upon the platen only on such areas where embossing is to take place. In order to prevent the gripper from scraping off the embossing compound when an impression is made, turn over machine by hand until gripper has passed over the area of the platen where the compound has been applied. A thin sheet of blotting card is placed upon the compound. Now set impression control for light impression and turn over machine by hand. It is best to wipe off the female die first with thin oil to prevent the blotting paper from sticking to the die. You can also stick a piece of tissue paper with a drop of oil on the female die. Now trim off the edges of the

male die, that is, cut off the surplus compound squeezed out during impression. Now start the machine with low impression strength, then increase impression strength slowly so that the compound is pressed into all the fine details of the female die. This gradual increase of impression strength should take place during the hardening process of the compound. As soon as the compound is hardened, impression should no longer be adjusted. Now permit the embossing compound to dry until it can just be cut with a makeready knife and trim off excess around edges.

Finally, the male die is lightly powdered with talcum. We recommend that you make the male die the last thing in the afternoon so it can dry overnight. A male embossing die made in this manner will enable you to run many thousands of impressions without having the embossing lose its sharpness. Naturally, you will have to choose a stock for your run that is suitable for embossing.

When producing larger embossings, do not use maximum impression strength but only medium. Should this appear insufficient, it will be advisable to place an underlay (not more than 3 sheets bond paper) behind the female die.

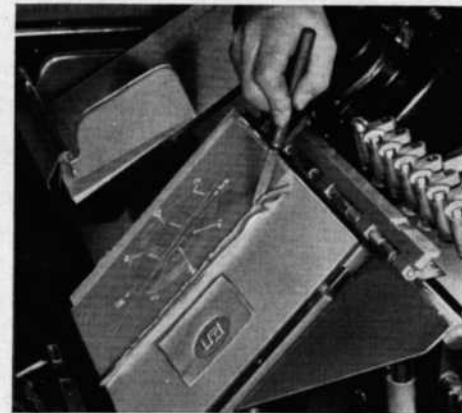
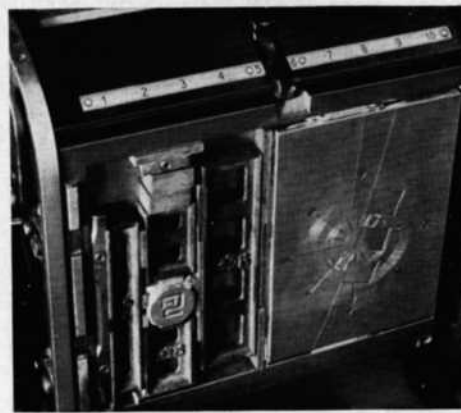

CARBON PRINTING

ON ORIGINAL HEIDELBERG PLATEN PRESSES WITH INK FOUNTAIN HEATING DEVICE

We are constantly seeking further methods of opening up new fields for letterpress printing. An ink fountain heating device has now been designed with which the printer can produce carbon prints on Original Heidelberg and thereby meet the present great demand for carbon prints.

The printer undertaking this work, although assisted by the ink fountain heating device and the many other technical advantages of the Original Heidelberg, will still need to consider various points to accomplish good results. The most important is the ink used. Carbon printing inks are mixed with wax and can only be used if the stiff ink in the ink fountain is heated so the rollers can take it on. The fountain heating device we have developed for all Heidelberg is a simple apparatus. It is only necessary to place it on the ink fountain after connecting it to an electrical socket. No changes on the machine are required.

The process of economical carbon printing on Original Heidelberg is as follows:

The Printing Plates

Any material that can take ink is suitable for use as the printing plate. Therefore, copper or zinc cuts, smoothly planed hardwood cuts brought up to type height, synthetic plates and also rubber plates, resistant to fat and oil can be used. Carbon printing is actually the printing of solids, and the type of plates used is not of prime concern.

The Packing

For both platen and cylinder printing, the packing should be soft and resilient. Adjust impression strength as low as possible to prevent the ink from squashing and to ensure that the ink film applied is not too thin.

Make-ready

Make-ready should be prepared carefully and with great accuracy to ensure that the ink film is applied to the paper evenly. The use of a rubber blanket, placed beneath the top sheet, and a few fill-ins is recommended, especially when metal printing plates are used.

The Rollers

The rollers should be resilient and—this applies especially to the form rollers—must be very carefully adjusted so that the ink is transferred evenly on the printing plates and no squashed edges result. If you produce carbon print jobs repeatedly, it is recommended that you have another set of rollers available.

The Paper

Select your stock with care. The harder the paper is, the better and the more durable the copying qualities will be. On the other hand, the use of hard paper may result in offset, which is not so acute in the case of softer, absorbent paper. The ink can penetrate more easily into the soft paper. However, by the penetration of the ink, the copying qualities are affected and the lasting quality is limited. The best paper to use is a paper which has a smooth hard surface. Cellulose paper is not suitable. It is advantageous if the paper contains a high degree of filling material as this prevents the carbon ink from showing through. It is advisable to make a few sample prints of the selected paper a few days in advance of the actual run and to watch the results obtained.

The Ink

Carbon printing inks differ fundamentally from other inks in that they should never be allowed to dry. Any additions which are

used for other inks, e.g. drying substances, siccatives, boiled linseed oil, etc. should not be used. The ink should always be used straight out of the can. In case a dilution is absolutely necessary, use only a specially prepared carbon paste. Usually, black carbon inks are used. There are, of course, other color hues, such as dark blue, red, violet, dark green, etc. to be had. The best copies can be produced by using green carbon inks. It is always important to print with a consistent ink quality. The carbon ink will not harden in the ink fountain due to heating device. This also enables printing with undiluted and viscous ink. However, when ordering carbon printing inks, mention the machine being used and that an ink fountain heating device is available. The ink house will then prepare an ink of stiffer consistency which will improve the copying qualities of the carbon. The quantity of ink should be much greater than when printing with ordinary letterpress inks. Offset is prevented by taking off the delivered sheets in small lifts.

Storage

The storage of carbon prints is a most important factor for the copying qualities and durability of the carbon prints. The prints should always be stored in a cool place and in no case close to the room heating. Do not store the sheets flat but on edge as is done with envelopes. If the prints are kept in a warm place, the copying qualities will soon be affected. It might be well to draw the attention of customers to this point. The use of the heating device for the ink fountain is not limited to carbon printing inks but can also be used in cold rooms to produce normal print jobs. It often happens that cold inks tend to "pick", especially when printshops are not heated. The heating device may be put to good use in eliminating difficulties which may arise when printing with regular inks.

0001*

NUMBERING ON ORIGINAL HEIDELBERG PLATEN PRESSES

To produce numbering jobs on the Heidelberg, plunger-type numbering machines are ordinarily used. These can be used in cases where only a limited number of machines, say 4, 6 or 8 are required. This quantity can be controlled easily. However, when a job calls for more numbering machines, plunger-type machines may present problems.

The ordinary type of plunger-operated machine will eventually wear down or damage the rollers. It might be well to investigate the low plunger type of machine. Such numbering machines, having a movement of only .40" are now available on the market.

If you have a great deal of numbering to do on your Original Heidelberg, we suggest that you look into the new device we have developed in cooperation with a numbering machine manufacturer. This was done to fully utilize the capabilities of the Heidelberg. This device insures numbering at top speeds, allows the use of more numbering machines, and precludes the usual troubles in numbering. Any desired quantity of machines can be put into position within the limits of the chase.

The numbering machines used in this device are centrally-driven. They can be fitted into a standard Heidelberg chase. Drive is furnished either by an actuating lever or by plunger units locked up on one side of the chase.

The actuating lever and the plunger units should be positioned so they are located beyond the end of the sheet. Generally, one plunger unit will operate up to five numbering machines.

When plunger units are locked up on one side, it is necessary to cut the form rollers on one side so that the plunger units do not contact the rollers.

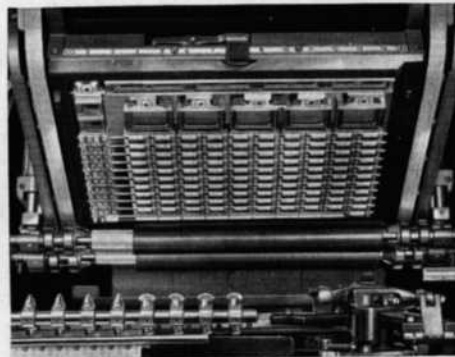
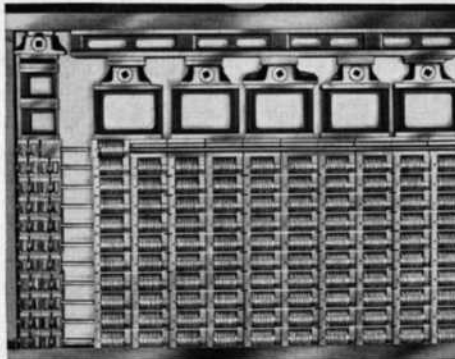
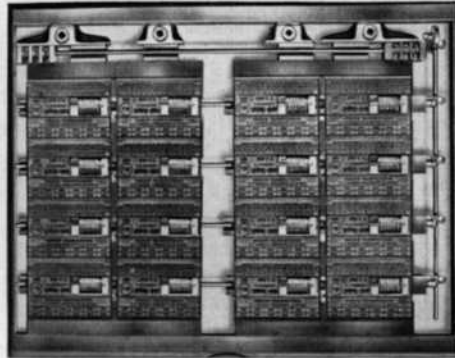

SLUR

(Also refer to pages 69-72)

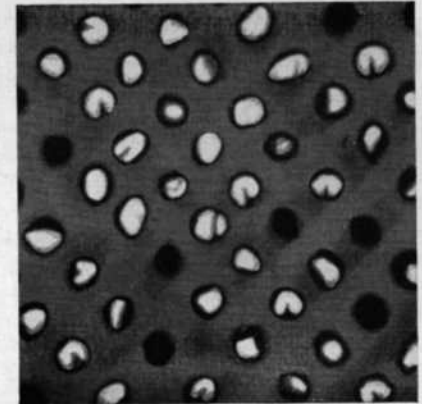

The pressman should thoroughly understand that there is a difference in slurs caused by too thin an ink, slurs caused by form rollers, and slurs caused because the ink is too tacky.

Slur Caused when Ink is too Thin

A thin-bodied ink can cause slurring on type matter, halftones and ruled forms. Close examination will show filling-in of the type face and the spaces between the screen dots in the halftone.

This can easily be detected in a halftone as the spaces between the dots are comparatively small and fill in more easily. When the ink is thin-bodied or there is insufficient impression, many pressmen tend to use too much ink attempting to get the desired coverage.

A slur is not so prominent on a deeply etched halftone because the dots are more pointed than those on a cut not etched as deeply. You'll find that this kind of slur appears more often on smooth stock than

on paper with a rough surface. In color work a slur caused by thin-bodied ink can even make the spaces between the dots darker in tone than the dots themselves.

When this slur first appears, it can be detected as small hairlines on the cut.

Slur Caused by Form Rollers

A slur caused by inferior or incorrectly set form rollers can appear anywhere on a printed sheet. When using rubber rollers, this slur may be caused by the deposit of varnish-like fragments from the roller surface. This glazed, crustlike coating results from using ink driers. It is therefore important to clean rollers regularly. Soak them overnight in a mild 5% lye solution, or apply a recommended regeneration paste to the surface and let them set overnight. This paste will dissolve the crust without affecting the rollers in any way. The next morning they can be cleaned off with a moist rag.

If rollers are not even or perfectly round, a slur will also result wherever the uneven part of the roller contacts the form. When examined under a glass, slurs which may be traced to roller difficulties show an excess of ink deposited on one side of the letter or line. The rollers may be hitting the form too hard. In this case, the tracks should be adjusted. If the rollers skid on the tracks, a slur will result. Always keep the roller trucks and tracks free from grease and oil.

Slur Caused when Ink is too Tacky

In platen press printing, a rather serious slur will result when the paper sticks to the form after printing and as it is pulled away by the gripper. The sheet is pulled sideways, causing the dots of a screen or the type face to be blurred (see illustration on page 71). This comes from using an ink that is too tacky. The remedy is to reduce the ink, if possible, by mixing it with an ink of the same color, but of thinner consistency. For example, a bond ink could be reduced with a job or halftone ink. When making ready, care should be taken that the packing is not bulgy or wavy. It is important that the ink be short, which can be ensured by adding starch or paste. It may also help to use a frisket, and very often a cross finger can also be put to good advantage.

The printed sheet should always leave the form easily. The air-blast from the right hand roller track on Heidebergs helps this considerably. The air from these holes helps to peel the sheet away from the form and keeps it smooth when it is swinging out. From time to time, these blow holes should be cleaned so that they remain open and serve their purpose.

Slur on Type Matter and Ruled Forms

This type of slur is usually described as a "trapped air" slur. It is caused by air which cannot easily escape from between the sheet and form when the platen closes. Compression forces the air out between the border and the paper, thereby producing a slur. One

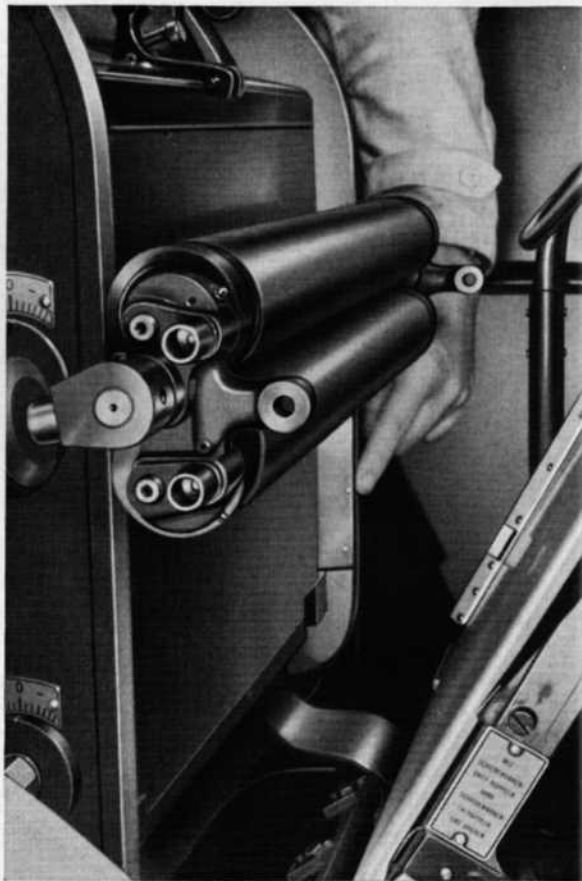

remedy is to lock up the form with hollow furniture. In some cases, pressmen will often remedy this by removing the borders from the form and drilling holes through them just below the printing surface.

When printing type matter and ruled forms, it is necessary to have a good hard packing and a tight tympan sheet. Bond inks are preferable on this type of work. Reduce the ink flow to a minimum. The use of friskets will also help to correct slurs. Curled stock can cause a slur on the end of a sheet. In most cases this can be overcome by using friskets.

CHECK YOUR KNOWLEDGE IN PRINTING TECHNIQUES

Eight questions for pressmen working with 10" x 15" and 12" x 18" Original Heidebergs

Solution on page 73

	YES	NO
1 Do you use a hard packing to print large solids and halftones on Original Heidelberg Platens?		
2 When printing black and white halftones on our platen presses, can you use the same ink as you would use on cylinder presses?		
3 When you pull an impression and find that it is heavier at the top than at the bottom, do you increase your packing thickness by inserting one or more sheets?		
4 When printing solids and a slur—caused by the ink—appears, do you dilute your ink by adding boiled linseed oil?		
5 Do you use composition rollers in order to eliminate ghosting?		
6 Can you get a quality print with gold ink directly on dull enameled stock?		
7 When printing a heavy form and if the machine stops with the platen on impression, do you try to get the press off impression by turning the flywheel backwards?		
8 When washing up the press, is the following sequence correct? a. Start press b. Engage wash-up blade c. Apply wash-up fluid		

GHOSTING

In letterpress printing, the form inking on cylinder and platen presses is dependent upon the "circumference-unrolling of ink" from the form rollers to the plates. The better the inking system breaks up the ink, the better the coverage will be. However, under certain conditions this inking principle does not prevent the form rollers from causing a "ghost mark" or "repeat mark" to appear on the print. This does not occur often but when it does, it is mostly due to printing large solids in certain color tones which also may have cut-outs. For the even inking of such areas, an ink is necessary which is rich in pigment and which has not been stretched or cut with transparent white or other printing aids.

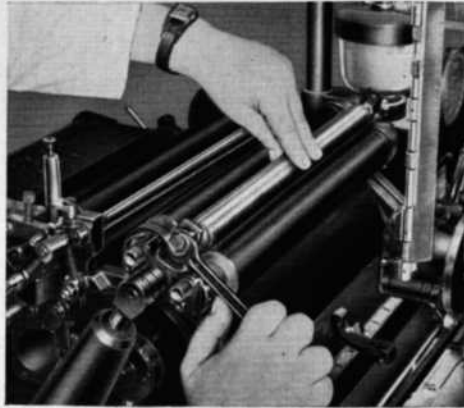

When mixing such ink tones, it is recommended to start off with a lighter ink tone with good covering strength and then add as much straight inks as needed for the required tone. The lightening of the ink with opaque white often results in leaving "crusts" on the rollers. This can be eliminated by adding a few drops of varnish to serve as a binding agent.

On jobs and inks tending to "ghost", it is advisable to use rubber rollers instead of composition rollers. Rubber rollers can carry more ink, and the ink can be more equally distributed on the form.

When ordering inks for solids, the ink company should be advised that the ink is for a solid. Such an ink is rich in pigment and has not been stretched or cut with transparent white or other printing aids.



**FOR THE PRESSMAN OPERATING THE
21x28" ORIGINAL HEIDELBERG CYLINDER**



PROCESS COLOR PRINTING ON ORIGINAL HEIDELBERG CYLINDERS

"Many roads lead to Rome" is an old saying. Several roads also lead to good process color printing. Therefore, our statements are confined to hints for the pressmen, and it is up to the individual to evaluate his own experience.

Whether yellow, black or blue is printed as the first color, and whether wet or powder spray should be used, are decisions which are left to the discretion of each printer. As already mentioned, our statements should be considered only as points of guidance.

The Plates

Good, deeply etched plates are a "must" for quality printing. For runs over 60,000 use copper plates, for smaller runs zinc plates will do. The screen depends upon the stock used. Super-coated book calls for a 120 screen, enameled stock for a 133 screen, while a highly enameled stock requires a finer screen up to 200 lines per inch.

The Paper

Best results in process color printing are obtained on highly enameled stocks. Usual

weights are 80 to 120 lbs. As the stock tends to change its texture across the grain, it is advisable to specify the desired grain direction when ordering paper. Generally, the printer will order paper with the grain running the long way of the sheet. However, the printer should also consider folding qualities of the paper. Close cooperation with the bindery can save a lot of trouble. The paper should be well seasoned so that the sheets will not stretch, contract or curl during the run and cause register differences. If the temperature and humidity in the stock room are not the same as in the pressroom, it is advisable to store the stock in the pressroom a few days before printing. If these hints are followed, the job can often be printed at much higher speed on full automatic machines.

The Ink

Generally speaking, the very best ink available will prove to be the most economical in high quality printing. This ink will have the desired color strength and body. Experienced printers will always use special

inks for solids, inks which are mixed similar to pigment-rich offset inks. They will also choose inks that are highly transparent and non-fading. For the use of printing aids, we refer you to page 66.

Anti-Offset Spray

When producing quality work, it is usually necessary to use a spray gun to prevent the printed sheets from off-setting. The choice of whether wet or dry spray is used is left to the pressman's discretion. The Original Heidelberg Cylinder is equipped with both spray systems. The amount of spray should be as light as possible.

The Rollers

The Original Heidelberg Cylinder is equipped with rubber rollers ideally suited for printing color work (we refer to our article on page 58 on Rubber Rollers). The setting of the form rollers should be precise.

Mounting of Plates on Metal Base

Most modern print shops use patent or light-weight metal bases for mounting plates. In our experience, we found it most practical to use metal bases manufactured on a typographic scale. Pieces come in alternating sizes and can be fitted together in accordance with the size and shape of the plates. On patent bases, the plates are fastened with toggle hooks.

Leveling Plates

It is mandatory to level the plates to exact type height. A type-high gauge measuring down to at least 0.0004" should be used for checking the entire surface of the plates. If they are low or uneven, level up by underlaying sheets of paper as needed. The plates should never be higher than 0.002" over type height.

Plates below type height require a heavier packing, plates above type height a lighter packing. In both cases, the "unrolling" of the cylinder will be affected because of the deviation from the correct type height. This may easily cause slur at the leaving edge of the plate.

Locking-up

After position has been obtained, the plates are locked-up in a "pivoting" manner. This is done by using one register quoin at each of the narrow sides of the mount, and two on each of the broad sides so that the entire mount and plate may be positioned exactly without disturbing the remainder of the form. To position plates correctly, Heidelberg's device for pre-registering forms is of considerable help.

This Speedy Form Positioner is furnished as standard equipment with the Original Heidelberg Cylinder. "Pivoting" allows the plate to be easily shifted for dot-for-dot registering. For registering, use areas in the middle of the subject. Do not register the plates with the edges of the subject.

The Packing

Throughout the world one can come across many variations in cylinder packing. Pressmen's tastes, availability of stock, and individual tricks of the trade are influential factors. Here is a fairly hard packing for process color work as used by many printers in Western parts of the world:

Starting with the cylinder . . .

- 2 sheets oiled manila (hangers)
- 1 sheet oiled manila in reel
- 4 to 5 sheets of 50 or 60 pound book paper (sufficient to bring overall packing to .047" including sheet being printed)
- 1 sheet oiled manila (hanger)
- 1 oiled manila top sheet in reel

Generally, the "oiled manila", also known as "treated tyman" is used in a .006" thickness.

Leveling-Up

Before preparing mechanical makeready, a general leveling-up should be made so that the press will print evenly. Areas that have insufficient impression are underlaid with folio or tissue paper. In this manner, a level impression is obtained. Only after the cuts are printing evenly should mechanical makeready be made. The pre-makeready is pasted on the first sheet of book paper nearest the cylinder.

Makeready

Solids and middletones require more impression than light areas or highlights. All makeready systems are based upon this principle:

- a. Hand-cut overlay: First, 4 sheets of 7-lb. folio are printed. From sheet No. 1 the darkest areas are cut out first and pasted onto sheet No. 4. From No. 2 the darkest areas and the middletones are cut out and pasted on sheet No. 4. On sheet No. 3 the extreme highlights are cut away and the remainder of this sheet is pasted onto sheet No. 4 in register.

Thus the darkest areas have four layers of folio and the middletones 3 layers. The highlights have one layer of folio, namely the fourth sheet upon which the hand-cut overlay was pasted. This completed hand-cut overlay (sheet No. 4) is then pasted to register on the spot sheet which, in turn, is pasted to the first sheet of book paper under the top manila hanger.

Do not forget to remove the sheet from the packing.

- b. Mechanical makeready systems:

When pulling a proof with mechanical makeready, a little more impression should be applied by adding a sheet of the job to the packing. Proof sheets should be

run through the machine twice with hair-line register. (Do not forget to remove the sheet from the packing.) To obtain the exact position for pasting on the leveling-up and the mechanical makeready, a printed sheet is fed, registered and transferred to the cylinder grippers. In this position, the sheet is stopped and stabbed.

Sequence of Inks

Usually the sequence of inks is determined by the progressives supplied by the plate-maker. When progressives are available, we recommend the sequence of blue, yellow, red and black for the following reasons:

- a. Blue ink coverage can be best controlled when it is used as the first color. By using blue first, an even tone is obtained throughout the entire run, whereas difficulties might be encountered when yellow is printed first. Using yellow as the first color is generally not too advisable, because its coverage cannot be checked properly. This is often the case when printing at night or in plants where lighting is not too good.
- b. The above sequence is not absolutely a hard and fast rule, for there are some cases where the sequence of black, yellow, red and blue is advisable, especially so when a pressman has to work without progressives.

Stacking the Printed Sheets

The printed sheets should be removed carefully. We recommend that they be taken out in small lifts of 500-700 sheets. Intermediate boards which are placed on small wooden blocks divide the various lifts until the entire stack can be wheeled away.

On each lift of prints place about 20-30 spoils to keep the top sheets from shrinking or stretching.

DIE-CUTTING

ON ORIGINAL HEIDELBERG CYLINDERS

The Original Heidelberg Cylinder is especially suitable for die-cutting because of its large cylinder and impression strength. You will find production speed higher than on most conventional die-cutting presses.

For the occasional die-cutting of small runs in the average plant, an untempered steel die-cutting jacket can be used. For volume die-cutting or long runs, a hardened steel jacket is recommended. Both types of jackets measure .0315" in thickness and can be supplied as an accessory by your Heidelberg dealer.

The jackets are designed to fit the cylinder securely and can be installed and removed in a minimum of time. The front edge is bent at a right angle to the jacket surface and is secured by the packing clamp. For extra security and for exact positioning, this front angled edge has holes that correspond with the packing pins in the clamping surface of the cylinder.

A canvas strip is riveted to the tail of the jacket. This canvas strip is wound on the rear tympan draw bar which draws the cutting jacket tightly to the cylinder surface.

When planning a die-cutting job on the OHC there are several important factors to consider.

First, and most important, the steel rules of the cutting die must not exceed type high, .918". (On special order, however, a type bed

for the OHC can be supplied for cutting dies .937" in height.)

Second, the flexibility of cardboard stock varies considerably and this rather than weight or thickness must be considered. In all cases, however, cardboard must be cut or run with the grain parallel to the cylinder axis, and thickness of the cardboard regardless of flexibility must not exceed .030" or 8 ply.

Preparing the OHC for die-cutting requires no alteration of the press or any special preparation. The inking rollers are removed, the cylinder is stripped of all packing for printing and the cutting jacket is placed on the impression cylinder.

Before putting on the cutting jacket, provisions must be made for makeready. A sheet of cardboard, preferably pressboard, and one hanger sheet having a combined thickness of .015" is sufficient. Both sheets should be scored and creased at the front edge just the same as normal packing sheets. The two sheets are pasted together along the clamping edge and then pasted to the clamping surface on the front edge of the cylinder. (It is important that the two packing sheets do not extend over the tail end of the cylinder printing surface, otherwise positioning and tightening of the jacket will tend to pull the sheets to the rear and also not allow the jacket to hug the cylinder.)

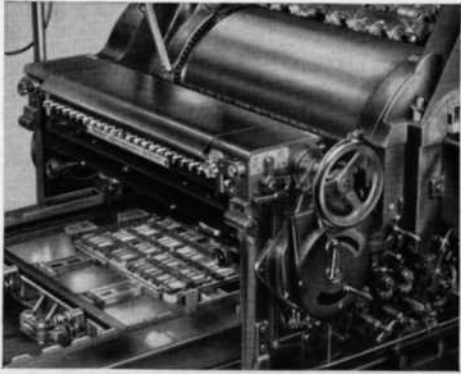

To place the jacket on the cylinder, the packing clamp is opened to its limit. Then the machine is turned backwards by hand until the tympan drawbar area of the cylinder is up. The jacket is then placed across the cylinder with the canvas strip hanging loosely under the rear drawbar. As the machine continues to turn in reverse, the jacket is guided into position on the cylinder. The clamping edge of the jacket is placed over the packing pins and is then secured by the packing clamp. The machine is now turned forward until the tympan bars are accessible. The canvas strip is then reeled on the rear drawbar and tightly drawn. The jacket is removed in reverse sequence. Placement or removal of the jacket should be done carefully to prevent it from being bent or dented.

Die Cutting of Small Forms

Very often the design or layout of a particular job calls for a comparatively small die-cutting form in proportion to sheet size. In such cases it is not necessary to use or purchase the cutting jacket that has been described. Instead, a piece of sheet steel the size of the die is sufficient. Because of its non-corrosive qualities and toughness, we recommend stainless steel for this purpose. The thickness of the plate should be approximately .035" and curved slightly less than the arc of the cylinder. When placed

on the cylinder the slight difference in curve will prevent the edges running across the cylinder from projecting or springing upwards.

The plate is attached to the cylinder surface with double-sided adhesive similar to that used for mounting cuts. Before attaching the die-cutting plate to the cylinder the total thickness of the plate, packing and adhesive must be considered carefully. The total combined thickness should not exceed .047". Therefore, assuming that the die-cutting plate is .035" in thickness, .012" must be added under the plate to bring up to the required total thickness of .047". In this case two layers of adhesive tape of average thickness would be sufficient. The adhesive is first applied to the cylinder surface and should be at least 1/4" larger than the cutting plate. The plate is then pressed firmly onto the adhesive and pounded down with the heel of the hand until it is in full contact with the adhesive. Finally, a light coating of glue is applied to the surface of the plate and a full top sheet is placed on the cylinder.

If a small die is located unusually in the form, or if the latter contains several small dies, it is sometimes advisable to carry the normal packing on the cylinder but cut out under the top sheet for the die-cutting plate or plates. This will permit stock of lighter weights to lay smoothly on the cylinder.

The preceding method does not conveniently

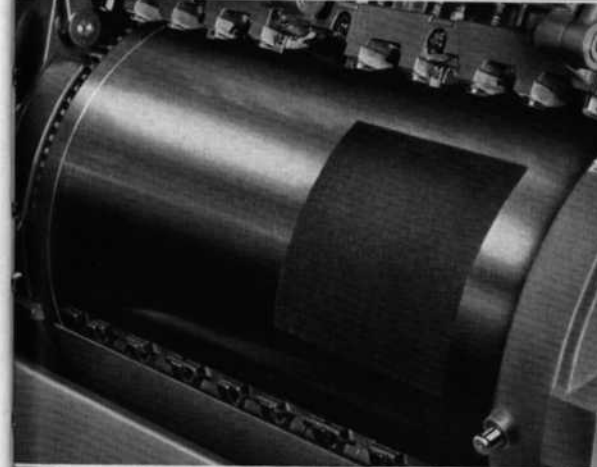
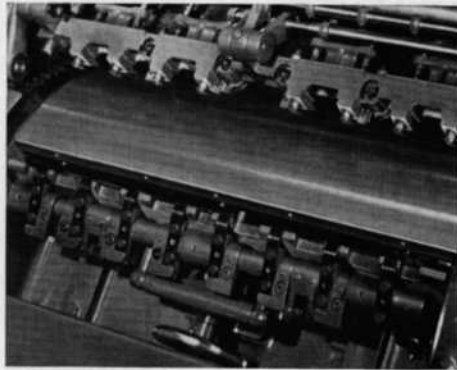

permit makeready to be placed under the plate. However, if the plate has been carefully mounted and total thickness is correct, little or no makeready will be required. Minor makeready can be made under the form.

Volume Die-cutting

It was previously mentioned that a hardened steel die-cutting jacket is recommended for volume die-cutting or long runs on the OHC. This steel jacket is designed similar to the softer jacket, but is tempered and ground and is extremely accurate. Being harder than the rules of the cutting die, the rules cannot cut into its surface. Because of this hardness and accuracy, the cutting edges of the rule are preserved. This gives sharp and clean cutting on longer runs.

In addition to this hard jacket we recommend the use of a hard steel plate under the form. This plate will preserve the surface of the type bed indefinitely and permit all makeready to be placed under the form—between the plate and the type bed—rather than the conventional method of placing it under the cutting jacket on the cylinder.

However, it requires cutting rule of special height. The normal height of .918" would have to be replaced by a rule .040" less in height, or .878". Since this is not a standard height rule in U.S. we revert to our preceding statement regarding the special type bed.

The special type bed can be supplied for existing OHCs if a volume of die-cutting is anticipated, however, it is preferable to order an OHC with the special type bed installed at the factory.

This special bed is of heavier construction and can be ground to provide for the steel plate of .040" under the form or for standard .918" cutting rules, or it can be furnished with two plates to permit die-cutting with rules of either height: .918" or .937". In this case the plate for .918" die-cutting would be left on the type bed when reverting to printing forms.

0001*

NUMBERING ON
ORIGINAL HEIDELBERG
CYLINDERS

For normal numbering jobs a special machine with an extremely low plunger has been developed and is now available. For jobs requiring large quantities of numbering machines in the form, an accessory to the press is available to operate centrally driven numbering machines.

Plunger-Type Numbering Machines

Numbering machines with a normal height plunger are not suitable for use on the 21 x 28 Original Heidelberg Cylinder. The high plungers will eventually damage the rollers and will print on the cylinder packing when impression is off. This is due to the fact that the clearance between the cylinder surface and the form is less than the plunger height of normal plunger operated numbering machines. Although the numbering machines do not actually trip, it is necessary to stop the press and wash the packing to prevent the plunger's imprint from offsetting onto the first several sheets of the run.

To overcome these disadvantages, machines were developed with an operating action and plunger height lower than the space between the cylinder and the form when the press is in the "off impression" position.

These newly developed low plunger numbering machines have proven to be completely satisfactory. However, like any plunger-type numbering machine, proper maintenance is of extreme importance for maximum and trouble-free performance.

Centrally Controlled Numbering Machines

To enable printers to get maximum advantage from the Original Heidelberg Cylinder's performance, a special device was developed to permit the use of center drive numbering machines. This mechanism enables the use of many more numbering machines, and extensive tests have proven that all machines in the form function perfectly without any sacrifice of press speed. Any desired quantity

of center drive machines can be locked in the chase up to its capacity. Shifting is completely dependable.

Center drive numbering machines can be locked up in any standard OHC chase. To accommodate the operating push bar, the chase is provided with .24" diameter holes in the right side of the head and tail bar. These two holes guide the operating push bar mechanism within the chase.

Chases furnished as standard equipment today are not provided with these holes, but they can easily be drilled by a service man. Swing levers can be attached to the push bar in any position at any distance from

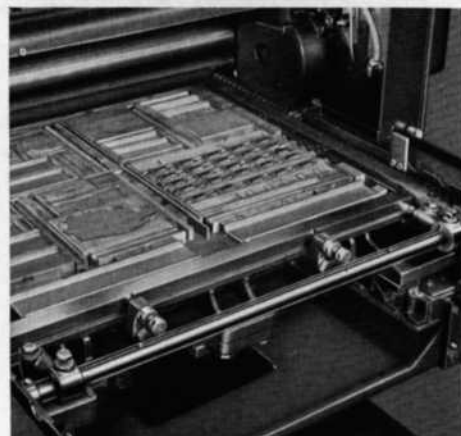
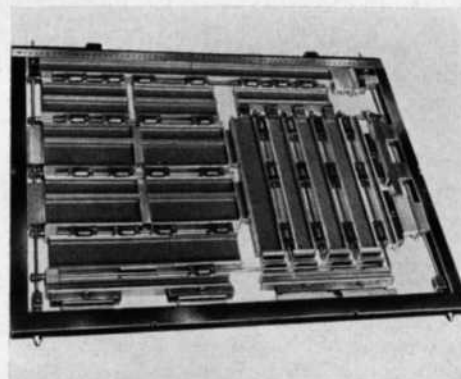

each other within the limits of the numbering machines and the chase. These swing levers are in turn attached to ends of shifting rods which serve a double purpose: holding and operating the positioned machines. The numbering machines are held through means of a center hole through which the shifting rod passes. Again, any number of machines can be positioned on the shifting rods within limits of the numbering machine size and chase capacity. Shifting rods can be ordered to any desired length. The numbering machines can be locked in the chase with standard quoins and furniture. It is also possible to use the center drive numbering machines together with type matter and plates. In such forms the plates are mounted on drilled or hollow base material through which the shifting rods can pass.

By using an added accessory, center drive numbering machines can also be positioned at right angles to the cylinder. Unlike plunger operated machines, center drive machines can be placed in either direction at right angles to the cylinder.

For operating the main push bar in the side of the chase, an attachment with two stops is mounted on the press. One stop is located at the rear and one at the front of the main base. The stop at the front can be engaged or disengaged manually, or the shaft on which the front stop is mounted can be removed from the press without tools when the machine is not being used for numbering. This front stop is connected to the main control lever of the press and works in conjunction with the fountain trip. Only when the press is on impression are the numbering machines in operation. If the impression is automatically thrown off, the front stop is raised and the numbering machines cease to function.

We recommend that the center drive mechanism be ordered with the 21 x 28 OHC so that it can be conveniently fitted at the factory. However, our dealers will be happy to supply and fit this device to presses which are already installed.

PROFITABLE **EMBOSSING** ON ORIGINAL HEIDELBERG CYLINDERS

The tremendous impressional strength and absolute rigidity of the Original Heidelberg Cylinder make it the only cylinder printing press suitable for economical production of heavy embossing. With due care in make-ready, the Heidelberg Cylinder can do embossing at an average of 3,000 IPH.

The Female Die

The embossing die should always be mounted on solid metal. For cold embossing the die can be mounted with double-sided adhesive foil, such as is used in mounting printing plates. Steel or brass engraved dies are the

most desirable, especially for long runs. For hot embossing, the female die is usually soldered or screwed onto the metal mount. The female die, including its base, must be exactly type high, otherwise proper contact with the male die cannot be made. When the female die is not exactly type high, unnecessary wear will result and ruin even the most carefully prepared male counter die.

Preparation of the Impression Cylinder

After the female die is locked in the chase, it is necessary to prepare the cylinder for the male die, or "counter", the relief counter-

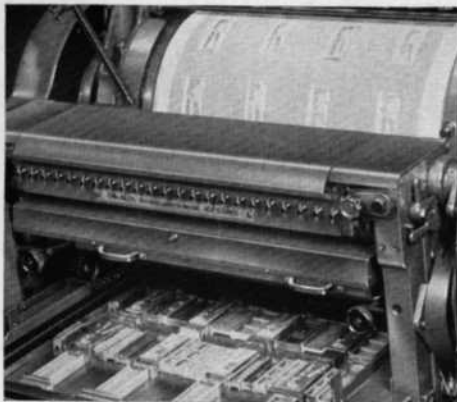
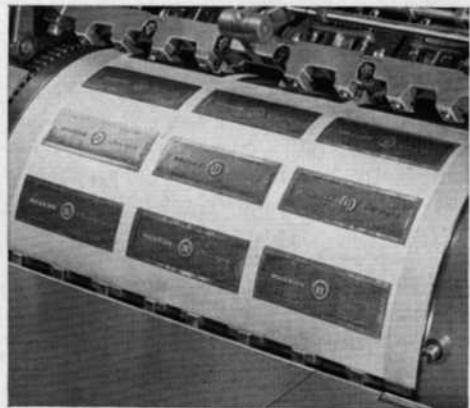

part of the engraved embossing die. It is attached to the impression cylinder and must contain **all** details of the female die in relief. First, cut a sheet of hard 10-point cardboard to the exact dimensions of the draw sheet. Cut a second sheet of the same weight to the size of a hanger sheet. Both sheets should be carefully scored at the gripper edge to permit an even and sharp fold at the gripper edge of the cylinder. It is recommended that holes be punched into the clamping edges of the board, rather than to try forcing the board over the packing pins. A much neater and smoother edge will result.

The two sheets of board are then placed on the cylinder. The top sheet, acting as a draw, is reeled to the rear tympan reel or draw bar. Under the two pieces of board, fill-in sheets are then loosely inserted to bring the total packing to .047". (The fill-in sheets are later removed.)

The die is now inked and the necessary number of sheets are run in order to attain final position of the die. After final position is determined, pull an impression on the packing or top sheet, and an impression on at least three sheets of heavy blotting paper which will be used for making the counter or male die. After this has been done, the loose sheets are taken from the packing, the inking rollers are removed from the press, and the die is cleaned.

The Male Die or Counter

From the first sheet of blotting paper on which impressions have been pulled, cut out the negative areas; that is, those areas of the die which did not print on the blotting paper, and paste them exactly in position on the impression previously pulled on the cylinder packing. Next, let the machine run on impression several times. The blotting paper is compressed into the engraved die, thereby shaping the counter die on the cylinder in relief.

This relief is not yet sufficient for embossing. The negative areas from the second blotter



sheet are now cut out and pasted over the first layer on the cylinder packing. Now again let the press run on impression several times in order to complete formation of the male die.

It is recommended that the male die be sprinkled with talcum powder prior to each run in order to prevent the fine detailed portions of it from sticking to the engraved female die. Should the male or counter die be weak at any point, tissue paper can be pasted over the weak areas. The depth of the female die may sometimes necessitate use of a third cutout of blotting paper. If the male die has been constructed properly and carefully, many thousands of impressions can be made with it.

If hot embossing is desired on the Original Heidelberg Cylinder, a heating unit is available. Sharper and more permanent detail is possible through hot embossing. It is especially desirable for embossing over bronze on dull finished paper. The hot embossing plate is a complete unit and does not require special fitting or any changes in the machine. This accessory can be obtained through your nearest Heidelberg dealer.

CARBON PRINTING

ON ORIGINAL HEIDELBERG CYLINDERS WITH INK FOUNTAIN HEATING DEVICE

There are numerous carbon printing jobs of comparatively short runs which can be economically handled on the Original Heidelberg Cylinder. The illustration shows the unit that can be furnished for heating the ink for carbon printing. Carbon inks contain wax. Therefore, it is necessary for the fountain to

be warmed while the machine is in use to ensure free flow of the carbon ink from the fountain to the ductor roller. The heating device can also be used to good advantage when the pressroom is cold, and ink flow is impeded. Also refer to pages 22/23 for further details on carbon ink printing.

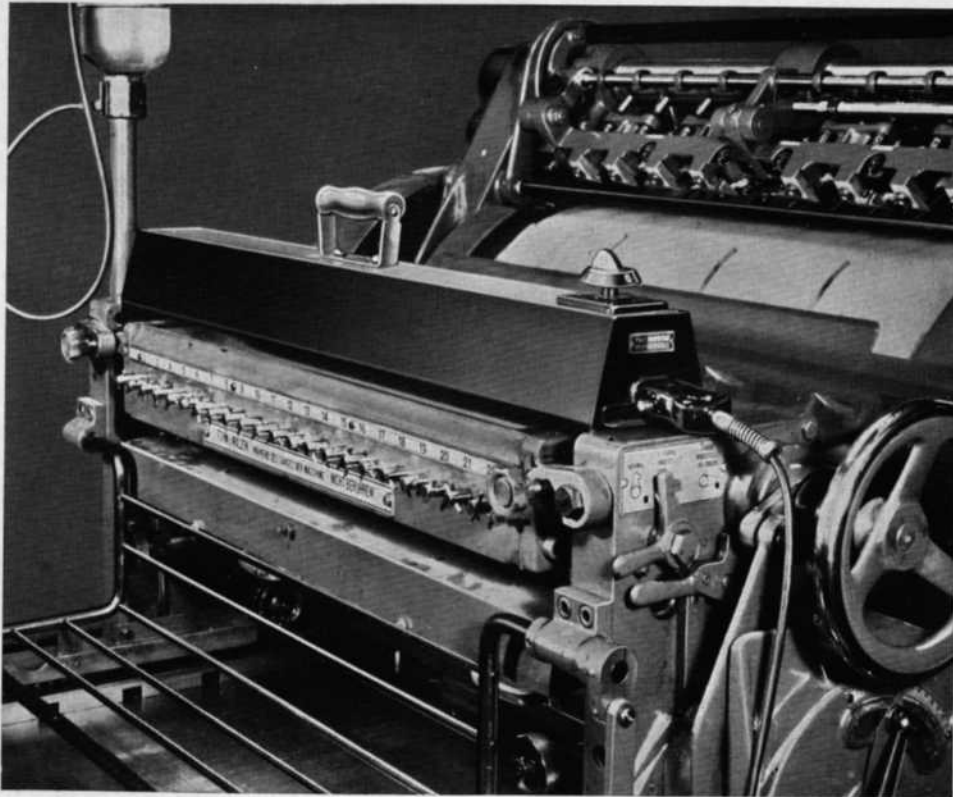

PREREQUISITES

FOR DOING QUALITY WORK ON ORIGINAL HEIDELBERG CYLINDERS

Correct Form Alignment

The Original Heidelberg Cylinder is a craftsman's machine, precision built and absolutely rigid. The cylinder of the Original Heidelberg Cylinder is free from deflection and remains firmly on its bearers under all conditions. Lack of such rigidity, so often found in less solidly constructed machines, greatly adds to the pressman's task. These facts play an all important part in reducing makeready time as the operator is not concerned with variations in the machine, but only with inaccuracies in the form. It is, therefore, worth while spending a little time bringing the form up to accuracy. Type is, or should be, type-high, but to get the best results from a half tone, especially a large one, the experienced printer will bring the cut up to a fraction over type height. The solid area of a cut requires more impression than the rest of the form. It is recommended that a pressman starts with cylinder packing slightly above or slightly below the prescribed thickness. Then add or take away sheets from the cylinder packing according to the impression required. The specified cylinder packing is .047", including the sheet to be printed.

Cut Justification

The height of a cut or plates can be accurately gauged only by means of a micrometer gauge similar to the ones shown on page 42. Type high rules and hand gauges are not accurate enough for modern standards. Our agents will be pleased to help you obtaining one.

Mounting of Plates

The material on which a plate is mounted and the method of affixing it to the mount is of paramount importance for good reproduction. Plates, nailed on wooden mounts do not come up to present day requirements, especially if the plate is a large one. All

plates should have metal mounts. The use of "honeycomb" patent base is recommended. The cylinder of the 21 x 28 Original Heidelberg is ground to the highest degree of mechanical precision. If the plate is mounted with equal precision, there is no room for give or variation in the production of good printing. It is not sufficient to fasten a large plate to its mount by its edges alone. Its whole area should be firmly affixed to its mount so that the center cannot spring. We, therefore, strongly recommend the use of the thinnest possible adhesive material (approximately .006") which will guarantee a firm and lasting contact with the mount. The printer should always bear in mind that the more work that can be done to a form

before it is put on the machine, the less time will be wasted and the lower the production costs will be. Modern printers do not nail plates. Each plate should be fastened separately over its whole area to an iron or aluminum alloy base of exact typographic measurements.

When using mounts care should be taken that they do not have ribbed side faces, as the furniture may rise and cause slurs. Finally, metal mounts should be purchased from approved suppliers only, as it is important that the material be absolutely square. The surface of the mounts must be precisely level or the plates cannot be held firmly over their entire area and will spring. This again results in slur.

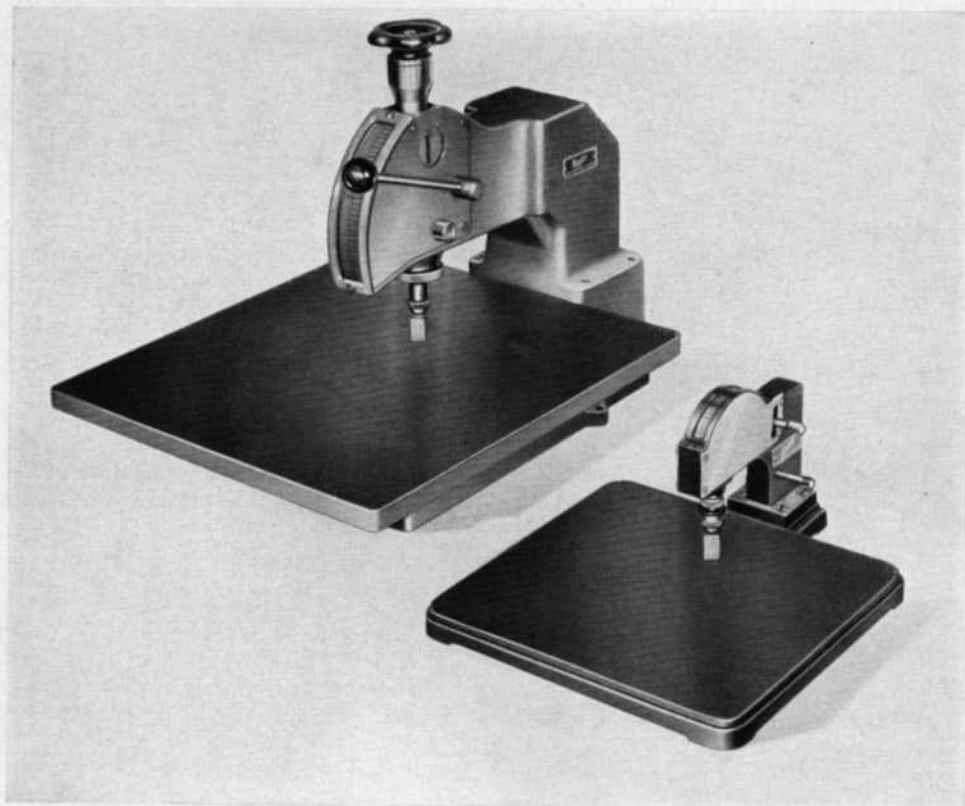

THE DEMON OF SLURS

Ever have a "devil of a time" with slurs? We do not know whether this demon is the little or the big brother of the demon of misprint. At any rate, he belongs to one of the dreaded family that often causes a printer to lose his temper. The hints on these pages should help you combat the demon of slurs.

Slur

Slur is one of the most annoying problems a printer has to face. It is a defect that can occur on a whole sheet or merely mar the appearance of one halftone. Slur distorts dot or type face and if not remedied at an early stage, can cause considerable damage to a halftone. The causes of slur are numerous, but only develop into a major problem when the printer is unable to detect the cause. We do not propose in this book to deal with every cause of slur but to make a few helpful suggestions on diagnosis and cure of the most common varieties.

However, before we deal with this subject we would like to emphasize that oil on the bearers may contribute to slur and particular care should be taken to see that they are clean.

Slur - Ink Too Thin

A thin bodied ink can cause a slur on type matter, halftones and rule work. It can be detected by the filling up to the type face and spaces between the screen dots in a halftone. It is more readily detected in a half-

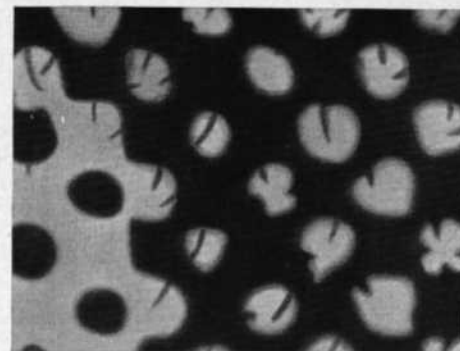
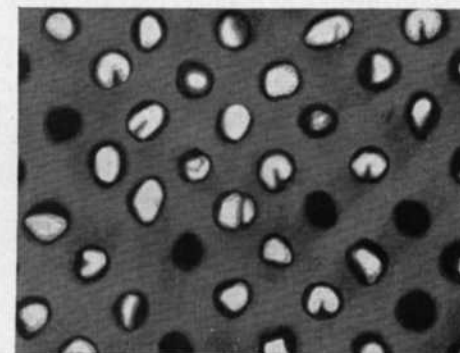

tone as the spaces between the dots are comparatively small and fill up more readily. With a thin bodied ink or insufficient impression, the operator is apt to use too much ink in an endeavor to obtain the desired depth of tone.

Presses with insufficient impression strength, therefore, may easily cause slur when printing heavier forms.

The slur is not so prominent on a deeply etched halftone as the dots are more pointed compared with those of a cut not so deeply etched. On stock with smooth surface this kind of slur appears more often than on stock with a rough surface. In color work, a slur caused by thin bodied ink can even make the spaces between the dots darker in tone than the dots themselves.

When this slur first appears, it can be detected by small tails in the spaces of the screen.

Slur - Ink Too Long

The use of the correct ink has a big bearing on the successful printing of solids or halftones with a fine screen. A slur in the printing of a solid can often be traced to the ink being too long or tacky. It usually produces an uneven strip of color which runs in a curve from the leaving edge and may be up to 1 1/2" wide. The edges of the slur are blurred. The cause, as mentioned above, is that the ink is too long and must be shortened. "Long" means that the ink can be drawn out between the fingers without breaking, and "short" when it breaks easily under the same test. The ink should not be too tacky. In no case should transparent white be used. The addition of paste is often of great help.

Slur - Caused by Form Rollers

While a slur caused by a tacky ink (see above) appears on the leaving edge of the sheet, a slur caused by either incorrectly set or inferior form rollers can appear anywhere on the printed sheet. It is caused by improper deposit of ink on the form.

When the form rollers are too low, a dark smudge appears on each side of a halftone, the edges of a type page are blurred, and the first and last lines of the page appear in a washed-out grey. A similar slur can also be caused by rollers being uneven or not perfectly round. In this case, the slur will appear wherever the uneven part of the roller contacts the form. This trouble may also be caused by rollers slipping over the form, as they may do when too hard, too soft, or lifeless. In these instances, the whole area of the cut will have a streaky appearance.

Slur - Caused by Poorly Mounted Plates

If plates are not mounted on perfectly true material, it is impossible to lock up the form accurately. The material in the form will spring towards the center, causing a slur to appear on the printed sheet. In halftones, this slur is easily recognized by an elongated dot pointing in opposite direction to the movement of the type bed, or by a distortion of the dot in any direction.

If the plate is not mounted correctly, it will slip and slur is caused again. Therefore, we repeat that modern printers do not nail plates but fasten them over their entire area with adhesive material to an iron or aluminum alloy base of exact typographic measurements or to metal mounts.

Slur - Caused by High or Low Cuts

This is a common type of slur and is usually the result of the form not being checked for height before being put on the machine. If the cuts are not of correct height, the pressman compensates for this by under- or over-packing the cylinder. This affects the ratio of cylinder to the bed, and the halftone dots are elongated or pear shaped, pointing either to the gripper or to the tail edge of the sheet, depending on whether the cut is too high or too low.

Frequently, the printer is unable to tell if the

form is type high as he seldom has a micrometer available. As a result, the machine may be blamed for inaccuracies that are actually present in the form. The engineer uses a micrometer to determine inaccuracies in the machine. It is just as necessary for the pressman to use a micrometer in selecting the proper amount of packing and determining the height of his cuts. It is essential that printshops keep pace with the advances made with the development of precision printing machinery. No doubt, there are many printers who despise the use of even an ordinary magnifying glass as an aid in production of good work. Under these circumstances, it is

obviously impossible to detect a slur before it becomes apparent to the naked eye. By that time, the plate or form has been irreparably damaged.

To detect a slur in its initial stages, even the ordinary magnifying glass is insufficient, as a magnification of at least 30 times is required. There are glasses on the market which are perfect for the job, giving a magnification of 50 or 60 times, and which should be part of the modern printer's equipment. With a glass of this type, a slur can be detected in the first proof, while it is still invisible to the naked eye, and unnoticed even with an ordinary magnifying glass.

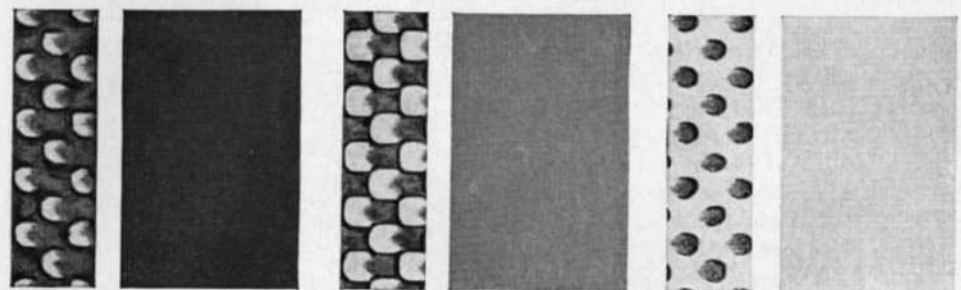

Cuts too Low - Cylinder Over-Packed. If the cuts are below type height, then the cylinder packing has to be increased to more than its prescribed thickness to get the necessary impression. The surface of the sheet then moves faster than the form, as it is now further away from the center of the cylinder than with the normal packing. This causes the sheet on the cylinder to move fractionally faster than the form on the bed and distortion or slur occurs. **The diagnosis shows the screen dot to be elongated and pointing toward the tail edge of the sheet.**

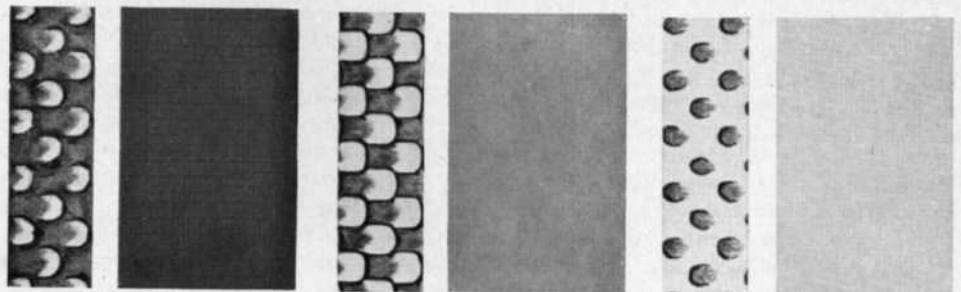

Cuts too High - Cylinder Under-Packed. Conversely, if the cuts are above type height the cylinder must of necessity be underpacked to compensate for this. In this case the sheet on the cylinder moves fractionally slower than the form. **Distortion occurs and the elongated dot points toward the gripper edge of the sheet.**

Type too high ↗

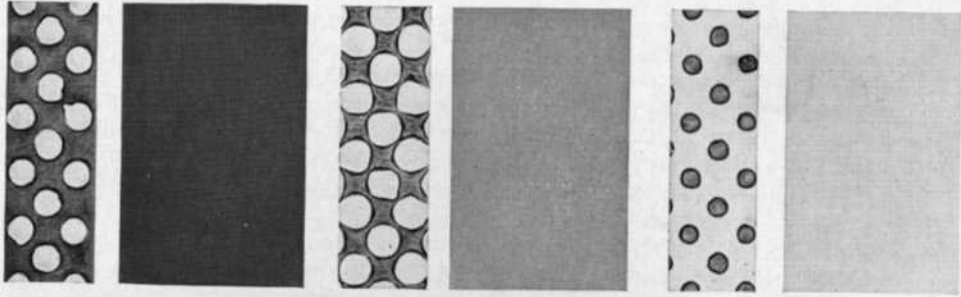

Cuts at Correct Height. If the cut is adjusted to its correct printing height the dot appears sharp and round.

Remedies

Before attempting to print, the pressman should examine the tail end of the sheet under his glass. From his observations it should not be difficult to decide what he must do if distortion of the dot occurs.

1. If he finds that the dot is slurred towards the leaving edge, the cut is too low. It must be brought up to type height and the cylinder packing reduced.
2. If he finds that the dot is slurred towards the gripper edge, the cut is too high. It must be lowered and the cylinder packing increased.

The illustrations show an exaggerated slur so that its direction can be more easily observed. Before running, the dot should appear round and sharp as shown in our third example. There should not be the slightest tendency to slur as this can only mean that there is a slight discrepancy between the surface rotation speed of the printed sheet and the corresponding speed of the form on the bed. Even the smallest discrepancy will cause damage to the form on a long run. Tendency to slur is more easily recognized in the lighter shades of a halftone, where the dot is isolated. It is more difficult to detect in the deeper shades, where the dots cluster and the spaces between them are observed as white or negative circles. Slurring may be

recognized in the deeper shades of a halftone when this "white" circle is flat on one side instead of being perfectly round. This flattening of the white circles is caused by the clustered dots slurring across them. If the circles are flattened in the direction of the gripper edge of the sheet, the slur is in the direction of the tail end. Conversely, if the circles are flat in the direction of the tail end of the sheet, the slur is in the direction of the gripper edge.

The direction of the slur is always detected by the flat part of the white circle and not by a heavier deposit of ink that fails to alter the shape of the circle. This heavier deposit of ink usually occurs on the opposite side of the flattened portion of the circle. Wherever possible, check for slur on the single dot in the lighter tones, where it is more easily recognized.

Before closing this chapter on slurring, we appreciate the fact that in the past many causes of slur could honestly be attributed to faulty mechanical conditions in a machine. Barring accidents, we are confident that the design of the Original Heidelberg Cylinder will prove its capability of eliminating slurs to owners and pressmen. In acknowledging the pressmen's technical skill in the application of ink to paper, we ask that every avenue be explored to find the cause of slurring before declaring the machine responsible.



GENERAL PART

The printing efficiency of Original Heidelberg can be fully utilized only when modern work methods are applied. The following section contains general information on modern work methods and printing aids.

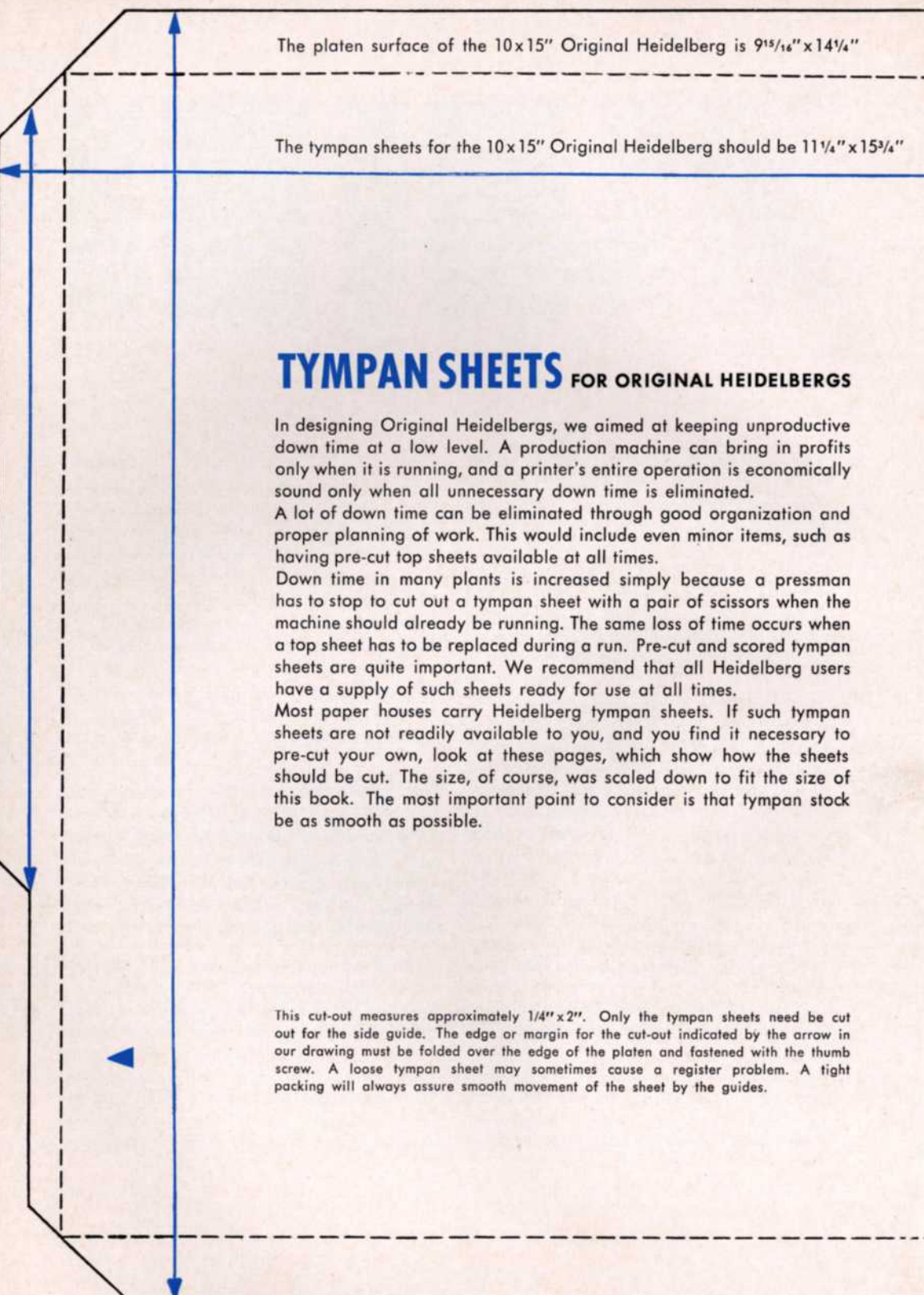

The platen surface of the 10x15" Original Heidelberg is 9⁵/₁₆" x 14¹/₄"

The tympans sheets for the 10x15" Original Heidelberg should be 11¹/₄" x 15³/₄"

TYMPAN SHEETS FOR ORIGINAL HEIDELBERGS

In designing Original Heidelberg presses, we aimed at keeping unproductive down time at a low level. A production machine can bring in profits only when it is running, and a printer's entire operation is economically sound only when all unnecessary down time is eliminated.

A lot of down time can be eliminated through good organization and proper planning of work. This would include even minor items, such as having pre-cut top sheets available at all times.

Down time in many plants is increased simply because a pressman has to stop to cut out a tympan sheet with a pair of scissors when the machine should already be running. The same loss of time occurs when a top sheet has to be replaced during a run. Pre-cut and scored tympan sheets are quite important. We recommend that all Heidelberg users have a supply of such sheets ready for use at all times.

Most paper houses carry Heidelberg tympan sheets. If such tympan sheets are not readily available to you, and you find it necessary to pre-cut your own, look at these pages, which show how the sheets should be cut. The size, of course, was scaled down to fit the size of this book. The most important point to consider is that tympan stock be as smooth as possible.

This cut-out measures approximately 1/4" x 2". Only the tympan sheets need be cut out for the side guide. The edge or margin for the cut-out indicated by the arrow in our drawing must be folded over the edge of the platen and fastened with the thumb screw. A loose tympan sheet may sometimes cause a register problem. A tight packing will always assure smooth movement of the sheet by the guides.

The platen surface of the 12x18" Original Heidelberg is 12⁷/₈" x 17³/₄"

The tympan sheets for the 12x18" Original Heidelberg should be 14¹/₄" x 19"

TYMPAN SHEETS FOR THE 10x15" ORIGINAL HEIDELBERG

The dash line on this sheet indicates the reduced area of the platen surface. Remember that this has been scaled down to fit "Hints for the Pressman". The actual platen surface of the 10x15 Original Heidelberg measures 9⁵/₁₆" x 14¹/₄". The tympan sheets for the 10x15 Original Heidelberg should be 11¹/₄" x 15³/₄". All four corners of the tympan are cut off to the border of the platen surface (that is, up to the border, as our diagram shows). The tympan sheets should also have an additional cut-out for the side guide and the thumb screw. As shown, it is cut out to about 2" in length, and in towards the interior approximately 1/4".

The first sheet underneath the tympan on which makeready is pasted measures 11¹/₄" x 14¹/₄". Since it is just as wide as the platen surface, it is not necessary to turn the sheet down at the left and right.

To prevent the makeready sheet from slipping, paste it to the lower platen edge. The tympan and the makeready sheet are then clamped together at the bottom edge with the tympan bar.

TYMPAN SHEETS FOR THE 12x18" ORIGINAL HEIDELBERG

The platen surface of the 12x18 Original Heidelberg is 12⁷/₈" x 17³/₄" (see outer line). We recommend a tympan sheet of 14¹/₄" x 19". A cut-out on the tympan sheet for the side guide is not necessary for the 12x18 Original Heidelberg. The corners should be trimmed off to the edge of the platen surface so that the four sides can be turned down smoothly and clamped with the tympan bars and the side clamp. The makeready sheet for the 12x18 Original Heidelberg should be as wide as the platen surface, 17³/₄". This sheet is not folded over the left and right. It is merely pasted at the bottom and clamped at the top with a tympan bar.

TYPAN SHEET FOR THE 21 x 28" ORIGINAL HEIDELBERG CYLINDER

In packing a cylinder, use only the best grade of tympan, a type that can be stretched tightly without tearing. Always check paper thickness with a micrometer or type gauge.

Ready-cut tympan sheets for the Original Heidelberg Cylinder are available from most paper suppliers. The drawing shows the measurements for this tympan sheet. The width is 28 $\frac{1}{3}$ ". Be sure that the tympan is never wider so as to protrude over the bearers.

As stated before, standard size tympan sheets for the Original Heidelberg Cylinder are

available from most major paper suppliers. However, if you find it necessary to prepare these from a roll, we recommend that they be cut to a length of approximately 39". The sheet should be trimmed off at the end where it is reeled in. The distance from the head of the tympan to the point where it begins to narrow is 21".

Since the clamp securely holds the packing, it is not necessary to paste on the makeready hanger sheet.

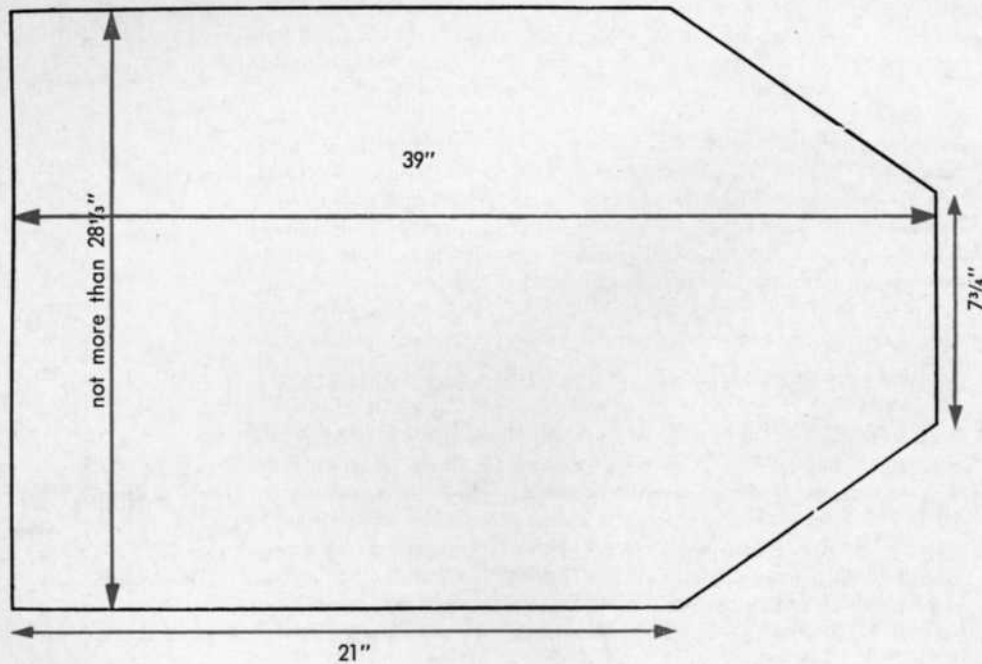

CHECK YOUR KNOWLEDGE IN PRINTING TECHNIQUES

Here are 8 questions for pressmen operating the 21 x 28" Original Heidelberg Cylinder. It is always interesting to check your "know-how" in press work. Mark the "Yes" or "No" columns with an "X" and then check your answers on page 74. Be your own judge as to whether you are satisfied with your knowledge.

	YES	NO
1 .. When printing a halftone, you find that the dot is slurred towards the tail edge of the sheet. Do you reduce the cylinder packing by one sheet which is placed under the cut?		
2 .. The rubber rollers are glazed. Since the roller washing fluid does not clean the rollers, do you try to remove ink crust by rubbing the rollers with type cleaner?		
3 .. In using die-cutting rule on the Original Heidelberg Cylinder, should it be somewhat over type-high?		
4 .. When printing a solid, the ink picks. Do you try to eliminate this problem by adding reducer?		
5 .. Is it correct to fill the oil gun with grease for use on the points provided with lubricating nipples?		
6 .. When starting the press up on a register job, the first sheet through the press does not register. Does this mean something is wrong in the sheet transfer mechanism?		
7 .. When printing cardboard, should the grain run the short way of the cylinder?		
8 .. When printing an ordinary type form, can you remove the third and fourth form rollers and produce this job with two form rollers?		

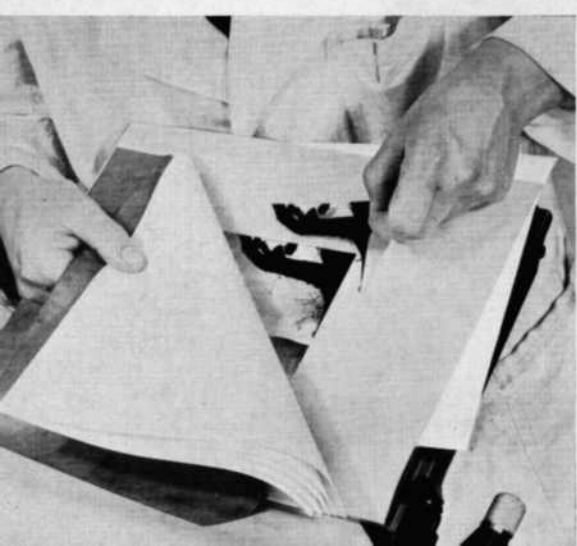
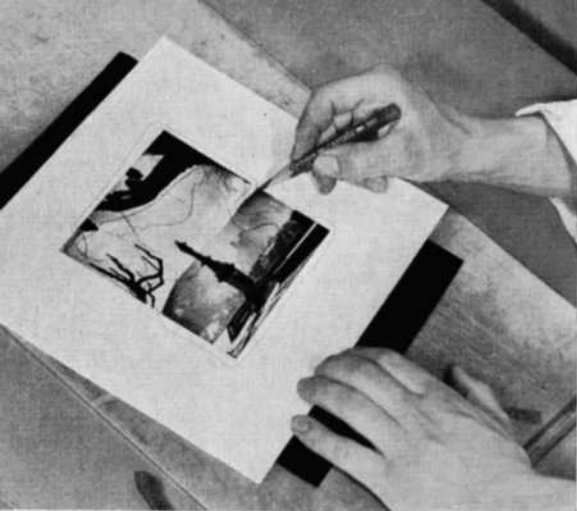

LEVELING-UP AND SPOT WORK

If a halftone is to have many contrasts and the greatest tone richness, it will require proper makeready. This results in the solids receiving more impression than the halftones and highlights. A pressman must first see that the cut prints evenly. Areas with a weak impression are spotted up with tissue. To locate these areas, an impression is pulled on a sheet. This sheet is placed face up on carbon paper, with the back side contacting the carbon. The areas with weak impression are marked by tracing them on the face of the sheet. The marked areas can then be spotted step by step with two or three layers of tissue. These tracings will be transferred to the back of the sheet by the carbon paper. This spot sheet is pasted on the hanger sheet. Later, the mechanical or hand-cut overlay is placed over the spot sheet. We recommend that a rubber blanket be placed over makeready. This keeps the ink from being squeezed away from the screen dots, gives a sharper impression, and prevents a mottled appearance. Some pressmen will use a sheet of blotting paper; however, we do not feel that it serves the purpose as well as a rubber blanket.

The following page shows how to make a hand-cut overlay quickly and simply.



Pull an impression on each of four sheets of 7-lb folio. Let's call these sheets A, B, C, and D. Cut out the solids of sheet A and paste to register on sheet D.



Cut the solids and the middletones out of sheet B and paste to register on sheet D.



Cut away the extreme highlights only on sheet C and paste this sheet on sheet D to register.

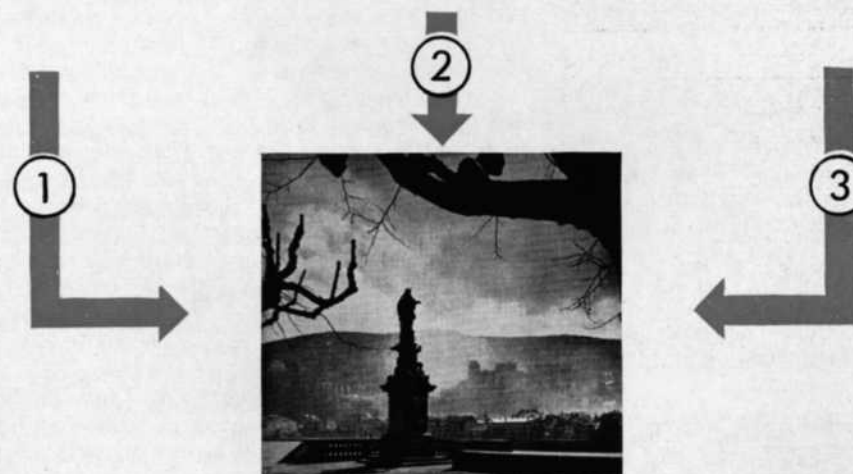

This completed hand-cut overlay (sheet D) is then pasted to register on the spot sheet. Next, place a rubber blanket over the makeready. Before putting on the top sheet, which

must be folded and clamped on all four sides, enough packing sheets should be removed to keep the prescribed thickness of the entire packing and makeready.



MECHANICAL MAKEREADY SYSTEMS

Just as hand-cut overlays are based on the rule that solids require more impression than highlights, the mechanical chalk overlay follows on the same principle.

Mechanical overlays should therefore be able to withstand long run wear because true and crisp reproduction of all tone values is a basic requisite. The ultimate objective of good engravers is true and correct reproduction of all tone values through use of improved methods. The printer, of course, should support these efforts by using up-to-date makeready methods.

For a faultless makeready, see that the cut prints evenly. After this is insured, pull two impressions in succession with hairline register ... using the special ink for this process. This ink should be used out of the can and without addition of any oils, varnishes or reducers.

After pulling the impressions, rub a little French chalk or talcum powder over the print. Before placing the foil into the etching solution, cut-outs are made at the corners or other striking points with a width of about 9 points. This is done to obtain position points for pasting up the mechanical makeready. Next, prepare the solution with etching powder. Following the instructions on the container, dissolve about 5 drams of powder in 2 pints of water having a temperature between 59 and 65 degrees Fahrenheit. Cold water will hamper the etching process, so if necessary, heat the water first.

While immersing the overlay in the etching solution, care should be taken that both sides are immediately covered by the solution and that the foil is constantly kept in motion. Now and then pick up the foil by the margin and turn it over.

Test progress of etching by removing it from the bath. If the reddish layer can be rubbed off the margin between two fingers to show the white surface of lower base sheet, then the etching process is completed. Now, using a cotton swab, rub lightly over the foil. The foil is correctly etched if the highlights show the white of the base sheet, the medium tones appear in a reddish hue and the solids still remain covered by the black etching ink.

The overlay foil should then be thoroughly rinsed and pressed between blotting paper. Talcum powder should then be rubbed over the dry foil. When made properly, the overlays can be used repeatedly.



THE PRIMATON MAKEREADY PROCESS

The Primaton makeready is a thermo-plastic method of makeready. It results in a graduated overlay surface (dependent upon line screen of the cut) to eliminate ink fill-ins and mottling in subtle halftones. Primaton makeready plastic powders cover four grades, and the relief of this makeready depends chiefly upon the grade of powder used. Always use Grade I for Original Heidelberg. The tack of the powder depends upon the amount of ink used.

The more ink, the better the microscopic Primaton powder granules, and the more pressure they will create. The density of the powder is therefore the determining factor for bringing out the various tone graduations within the cut. Preparing a Primaton overlay is simple. It is important that the cut prints evenly. In most cases, a standard ink may be used if a few drops of special blending agent (Fiegsol) are applied to the form rollers. If a standard ink proves to be unsatisfactory, a special ink can be procured. The Primaton makeready ink has certain constringent properties. If 3 or 4 minutes are allowed to elapse between the inking of the form and the actual impression, crisper tone values can be obtained.

Make cut-outs at the corners or other striking areas of the sheet about 9 points wide, so that the mechanical makeready can be pasted on in correct position. However, nothing should be cut away from the sheet. After being placed in a flat tray, pour Primaton powder Grade I over the print. Use a broad soft brush to work the powder back and forth over the sheet surface until the powder dissolves in the highlights. After this is done, the sheet is then treated in a second tray with blue powder Grade 0. This blue powder serves to fill and develop the most delicate tones. Minor corrections can be made with a small camel-hair brush, makeready knife, and a wad of cotton. Next, clean off all powder that may be on the back side. The overlay is then heat-treated by holding and slowly moving it back and forth over a heater at a constant temperature between 260 and 330 degrees Fahrenheit.

When the white hue of the powder has completely disappeared and the overlay shows a dull finish over the entire surface, it is then ready to be used.



GOLD INK PRINTING

The use of metallic inks has been greatly increased within the past several years. This is due largely to marvelous improvements in the metallic inks.

First, one should know that there are still two methods being used in metallic ink printing, even though one of them is used to a lesser degree. This older method refers to the use of bronze powder which is applied to those parts of the freshly printed sheets on which a base color has been applied. Metal powder is distributed over the inked areas by hand with a wad of cotton and then dusted, or mechanically by a bronzing machine which performs the combined operations.

Metallic inks are prepared by mixing metal powder and special varnish supplied by ink houses. Some silver metallic inks are already pre-mixed and can be used straight from the can. This type is made by combining varnish and silver paste rather than powder and varnish.

Depending upon which particular manufacturer's ink is used, preparation of the ink

may vary a bit; however, general procedure is about the same.

Preparation of Ink

Makeready in another color. Add varnish to gold powder in proportions of approximately 4 parts varnish to 5 parts gold by weight, or 3 parts of varnish to one part of gold by volume. Fresh ink insures best results, so thoroughly mix a minimum quantity at a time. Add fresh ink to fountain periodically during the run. On long runs, some printers have been known to use an electrical household mixing appliance to keep the ink fresh. Never mix more gold ink than you need or intend to use during the day, because it has a tendency to tarnish. When printing solid areas, increase proportion of the gold powder and when printing very fine work, increase proportion of the varnish.

Papers with a smooth or coated finish give the most satisfactory results. A straight mix can be used on such stock; however, on some it may be necessary to lay down a yellow base for running the metallic ink. When printing fine work which must register, it is recommended that a transparent base be used. Dull coated stocks will generally require use of a base ink. On very absorbent or rough papers, ask your ink supplier for a special base ink. On some particular jobs or papers, it may be necessary to run the sheets through twice in gold to get the best results.

Rollers should have ample tack but neither hard nor soft. New rollers should never be used. It is best to use rollers that have been run in and can be set precisely and easily. Impression should be as light as possible, and form rollers should pass over the form lightly and evenly. As on all other jobs, make certain that the form is type high.

Packing should be rather soft. Some pressmen get best results by using a rubber blanket under the top sheet and necessary soft sheets.

Washup at midday if necessary and, in every case, at the end of the day. Never leave metallic inks in the fountain overnight.

GLOSS INKS AND STOCK

Printed matter with a glossy surface has always been appealing to customers. The demand is still increasing because customers like brilliant high-gloss tones. Up to now, demands for gloss or surface protection were generally met by varnishing. This is either done with a varnishing machine or by overprinting a glossy cover varnish. Varnishing requires both effort and a great deal of skill. The pressman must keep a watchful eye on the run. He must carefully stack the entire run in small lifts so that the freshly printed sheets will not stick together.

By using an ordinary varnishing machine, varnishing with spirit or nitro-lacquer is much easier and faster. Another advantage is that the varnished sheets are quite dry when delivered. However, either process means a considerable price increase of the printed matter. Besides, inks fast to varnishing have to be used for printing. Spirit varnishes and especially nitro-lacquer require special selection of color pigments. Furthermore, there are some color gradations; for instance, bright pink cannot be manufactured absolutely fast to varnishing. That is why spirit and nitro-lacquer inks fast to varnishing are always more expensive than standard inks. For this reason, printers sought to produce high-gloss prints without spending a lot of money and effort for varnishing. However, it was not possible to obtain satisfactory results with inks and stocks available. Either the paper absorbed too much of the ink-binding agents, leaving none or only a poor gloss effect, or because of the rough paper surface the ink covered the stock unevenly. The print was mottled and unattractive.

Now, new types of stock are available on the market, one of these is KROMEKOTE which first appeared in the United States.

This stock has a mirror-like surface and when special inks are used, the printing results are just as good as varnished printed matter. If a printer wants to try this type of stock, he should observe the following points for best results:

1. Use only those themes which have a natural glossy effect and will become enhanced through glossy printing reproduction. For instance, it would be futile to reproduce watercolor in gloss drawing. This also applies to the reproduction of dull colored cloth and objects. In other words, the gloss should enhance, not impair the effect value.
2. For solids without screen, there are special gloss inks available which, however, are not suitable for halftones. The printing of solids is somewhat difficult because the smooth surface of the ink is obviously sensitive to offset during the drying process. Anti-offset spray should be used sparingly, otherwise the glossy effect may be impaired.
3. When using appropriate gloss inks, halftones, line cuts and medium-faced type matter will give excellent results since the glossy paper enhances the sheen of the inks. Use only those printing aids recommended by ink manufacturers. Since the inks dry fast, it is generally not necessary to add driers. If drying is to be accelerated, 1/2 to 1% of an average cobalt drier will do.
4. For multi-color printing, care should be taken that intervals between the individual color runs are not too long. Ink manufacturers have been working intensively on this problem. High-gloss inks which allow an interval of several days between the individual color runs are now available for multi-color halftones. At any rate, the ink manufacturer should be consulted before the inks are ordered.
5. Powder or wet spray is necessary, but keep it to a minimum, so that the gloss effect is not impaired.

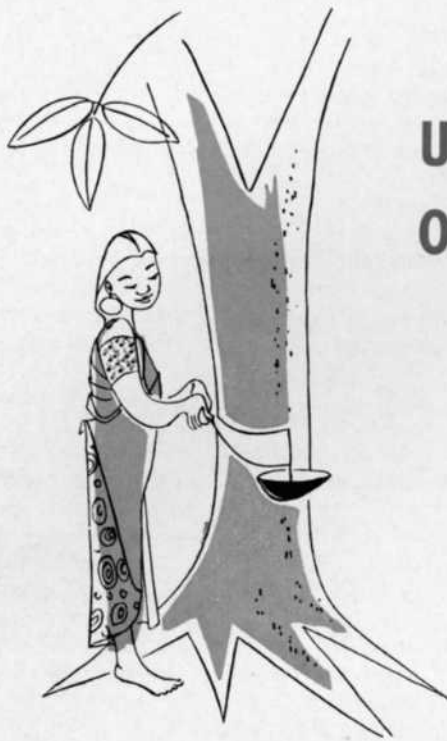

USE AND CARE OF RUBBER ROLLERS

When looking to manufacturers, distributors and dealers for quality printing machinery capable of the highest hourly output, printers also direct their attention towards the most suitable inks, anti-offset spray, rollers, and other expendable items.

To bring about improvements in auxiliary printing aids, manufacturers have for years experimented and cooperated with other firms who produce such supplies for printers. We would like to mention one example — rubber rollers. Most printers know that our Heidelberg presses are originally equipped with rubber rollers. These are the result of lengthy research and testing, and we are convinced that the best prints at high Original Heidelberg speeds can be secured with rubber

rollers. Occasionally, the particular "know how" of a pressman or a specific job on a given press may show a different type roller completely satisfactory, but from our overall experience on Heidebergs, we have found the rollers supplied to us more than adequate. If there is a given set of qualities to look for in a roller for a high speed press, we believe it would be as follows:

1. Moisture proof
2. Constant during weather changes
3. Resistant to effects of oil and cleaners
4. Elastic
5. Resilient and tacky
6. Durable

A few general rules to follow in caring for your rollers are these:

1. Whether operating a platen or cylinder press, be sure that your roller settings are checked regularly.
2. Use top quality cleaning solvents. Your local suppliers will be able to recommend the best grades.
3. By all means, use so-called "ink eradicators" with caution for many of them are highly volatile and can impair the roller covering.
4. In case inks or varnishes dry on the rollers, they should be rubbed over with certain regeneration pastes which are available and left to set overnight. Cleansing them with a little lukewarm water the next morning will restore velvet-like surface to the rollers.

For color change-over and especially in such cases when a dark color is followed by a light one, the following method has proven to be reliable in day-to-day work:

1. Wash up the inking apparatus and the form rollers. This can be done simply and quickly with the Heidelberg roller washing device.
2. Apply a little opaque white on the vibrator roller and then let the ink run up for a while.
3. Re-wash the inking apparatus including the form rollers.
4. Put the desired ink into the ink fountain. The tone of the colour should then be correct.

We would like to add here that Original Heidelberg's unique built-in automatic wash-up aids greatly in cleaning rollers and saves much of the time spent in this operation on other platens and cylinders. Washing all rollers, plus the form, can be done in a matter of seconds. Owners appreciate this for it means a clear saving in time and money. Rag costs are reduced up to 80%. Pressmen are made happy too, for hands stay clean.

PRACTICAL USE OF THE SPEEDY FORM POSITIONER

Speedy form positioners are furnished with Heidebergs as standard equipment. This pre-registering device enables a shop to do all preparatory form work in the composing room, thus reducing expensive down time on the press. In designing this, it was our desire to supply a form positioner which could be handled with speed and precision on both simple and complex forms.

The form positioner consists of a hinged transparent sheet with accurately positioned pins to fit into precision drilled holes in the chase. An image of the form is made on this transparent sheet, and the next form can be registered from this image. In most cases, second and succeeding colors can be locked up while the first form is already on the press. If a sample print of a job is available, even

the first color can be pre-positioned accurately.

The illustrations show use of the speedy form positioner when locking up process work. If a pencil is used skillfully, the various color plates can be locked up with "final proof" accuracy.

Your Heidelberg dealer also has available a transparent sheet which is marked with graph paper squares. Printshops that have a great deal of solid or rule work will find this very handy.

Also available for the 21 x 28 Original Heidelberg Cylinder is a composing stone which is an exact replica of the bed on the press. It is equipped with chase stops, chase locks, and side bearers, thus enabling a form to be locked up in the composing room just as it is on the bed.

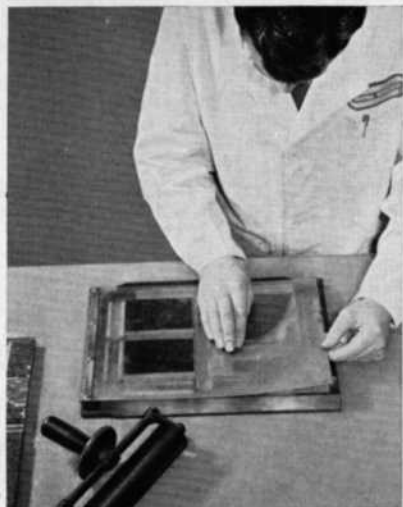

Illustration No. 1 – After the first color plates have been positioned, the form is inked with a hand brayer.

Illustration No. 2 – An image of the inked halftone (or type matter) is made by rubbing the palm of the hand over the transparent sheet.

Illustration No. 3 – Check to see that the image is accurate and that all essential areas appear on the sheet.

Illustration No. 4 – After the image is made, the succeeding color plates are positioned and locked up. A cloth moistened with type cleaner will easily remove the ink from the transparent sheet.

A FEW SUGGESTIONS ON

PRESSROOM SAFETY

Working in a printing plant is no more hazardous than working in any other industry. Accidents that occur in printing plants can generally be attributed to the same causes found in other types of plants. For the most part, they are due to **carelessness**. Here are a few points to remember:

1. Never attempt to lift or carry by hand anything that is too heavy or bulky to be handled safely by one person.
2. Keep aisles clear. If aisles are marked, see that the spaces between the aisle lines are unobstructed.
3. Space around the presses and other machines should be kept clear to permit free movement.
4. If inflammable solvents are used for cleaning type, rollers and the machine, they should be kept in safety cans. If you work in a "no smoking", adhere to this regulation strictly. Power should be shut off before making repairs on machinery.
5. Do not engage in practical jokes and horseplay in the pressroom.
6. Whenever making any minor adjustments when the press is running, be sure that your footing is secure and that you are looking directly at the item or mechanism which your hands will contact.
7. When press is running, hands should not be placed on any part of the press that cannot be seen from where the pressman is standing. (On both Heidelberg platens and cylinders, you'll find that press control mechanisms are quite simple, and that most of them can be handled from the operator's side.)
8. Only those operational adjustments as recommended by the manufacturer should be made while a press is running. Make mechanical adjustments only while machine is idle.
9. Never distract other equipment operators. Machines in operation demand their full attention.
10. Before starting a press, make certain that all tools are removed from the press and press platform.
11. Whenever it is necessary to leave the press after a breakdown or operating difficulty, turn off the power and place a "DON'T START" sign on the machine.
12. Floors, steps and press platforms should be kept free from oil, grease and ink.
13. Always wear clothing which is proper and safe for your job. Wiping rags should never be left hanging out of pockets when working around a press that is running.
14. Paper stock and finished jobs should be wheeled away as soon as possible to avoid overcrowding work space.
15. Never attempt to operate a machine when feeling ill or nauseous.
16. All injuries, no matter how slight, should be reported immediately.
17. Heidelberg's central lubrication supplies oil to all main bearings. This lubrication can be made while press is running. However, hand lubrication should only be done when press is idle.

BLIND PRINTING LINE - SPACING MATERIAL

Every day we receive a number of letters in which we are asked for advice on printing techniques. The pressmen in our demonstration printshop specialize in such matters and are always experimenting with new problems. We consider it an important phase of our after-sales service to handle each inquiry conscientiously.

"Hints for Pressman" space does not permit us to dwell in detail on every problem. We are limited to covering general tips and

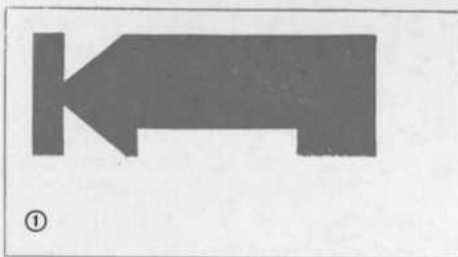

printing aids which many pressmen are already acquainted with; however, we still must consider those who are not too experienced. One such printing aid, for instance, is the use of spacing materials as a "blind printing line", a topic which we will discuss here.

Illustration No. 1 shows a mixed form of type matter and heavy solid. A smear occurred at the tail end of the solid. The cut was type-high and properly mounted, so this smear was not a slur caused by the cut being too low or too high, and neither was it a slur caused by the sheet falling onto the form at the tail end.



Solids, especially when the ink is too tacky, tend to smear towards the tail end (this is prevalent when enamel inks are used). Illustration No. 2 shows a blown-up view of the tail end of a solid.

The only remedy for this is the use of spacing material as a "blind printing line" to hold the sheet beyond the tail end of the solid without being printed.

When using enamelled stock, spacing material (approximately 2 picas in width) is locked up approximately $\frac{3}{8}$ " behind the tail end. This spacing material should, however, be below type-high so that it is not inked. It will suffice to stay .039" below type-height. Correspondingly, a strip of cardboard is pasted on the packing so that the sheet to be imprinted is held tight with normal pressure beyond the tail end.

Illustration No. 3 shows a transverse section

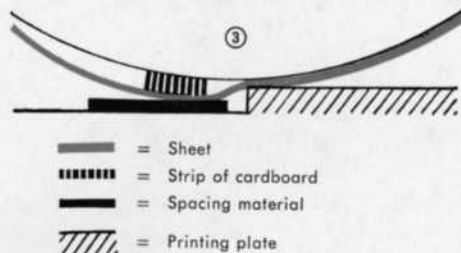

of the end of a cut with spacing material locked behind it. Please keep in mind that the distance should not be less than approximately $\frac{3}{8}$ ". Otherwise, the bending of the sheet may result in new smearing. For thicker stocks, the distance might even be increased. This practice assists greatly in overcoming one of those problems which cannot be attributed to the machine, but is peculiar to various types of forms, inks and papers. It is one of those little tricks which is a part of a letterpressman's repertoire and which makes his work so interesting. These difficulties occur very seldom on the Original Heidelberg Cylinder because of its larger cylinder diameter (21").

KASTOLINE

Printing of large solids will often result in repeat marks and mottling on the printed area. One way to overcome these difficulties is to use specially prepared inks. However, this usually means that an additional ink inventory must be carried, and this is not always economically feasible. Another point to consider is the time lost in preparation of new inks. To help printers "help themselves" in the preparation of such inks, the ink manufacturer Kast & Ehinger of Stuttgart-Feuerbach in Western Germany recently introduced a new printing paste called Kastoline. This new product is designed to facilitate the printing of solids, decrease the appear-

ance of roller marks and mottling, and to give more even inking. Hence Kastoline makes the ink lay smoother, reduces picking and peeling problems. Up to 30% of this paste can be added to inks used for the printing of solids. The color tone of the ink will not change when a small amount is added, but will be lightened somewhat if large quantities are used. This paste is suitable for all letterpress inks and usually does not affect the drying time.

Both we and many of our agencies throughout the world have experimented with Kastoline and found it to be a very valuable printing aid. We recommend it very highly to all letterpress printers.

OFFSET

Offsetting means that the ink from a wet print leaves a faint or partial impression on the back of the next sheet. Offset usually occurs on smooth or hard papers. The offset spray apparatus on Heidelberg's aids immeasurably in preventing offset. The liquid or powder is sprayed over the printed surface in minute particles. These tiny particles of spray form microscopic beads to hold the sheets apart.

We recommend that you check with your Heidelberg dealer as to what type of spray should be used for fast-running Original Heidelberg's. He'll be happy to recommend quality brands to you. When you are faced

with an offset problem, also consider these points:

- Too much ink - when used to excess, it cannot oxidize or be absorbed properly.
- Make sure that you are using the right type of ink for the stock being used.
- Careless handling of freshly printed sheets will result in offset. Do not use any pressure or attempt to jog the sheets until the ink is completely dry.
- Excessive humidity will also cause offset when using certain types of stock. Moisture-laden paper resists drying. Remember, too, that in dry air, static causes sheets to cling together tightly, and this, too, will cause offsetting.

COLOR REFUSING TO TAKE

In multi-color printing, the second, third, or fourth color may not be "taken" by the preceding color. This is caused by the fact that the first color dries too quickly and does not remain open. In other cases, use of an unsuitable drier can cause the ink to harden too quickly so that succeeding colors cannot

be trapped. To prevent this, we recommend the addition of a small amount of linseed oil. Use driers sparingly on the first colors. Succeeding colors should be printed with as little interval as possible. In some cases, the problem of succeeding colors not taking can be overcome by increasing impression strength.

TYMPAN PACKING

The prescribed packing thickness for 10x15 and 12x18 Original Heidelberg Platen Presses is .040". For the 21x28 Original Heidelberg Cylinder the prescribed packing thickness is .047". Correct packing on both the 10x15 and 12x18 Platen presses is extremely important and can readily be corrected when pulling the first impression.

If the impression is too heavy on the bottom and light at the top, too much packing is being used. Remove one or more packing sheets and increase the impression slightly. When the impression is too heavy at the top and light on the bottom, the packing is not thick enough. Add one or more sheets to the packing and reduce the impression.

Correct packing is of equal importance when printing on the 21x28 OHC. It is extremely important that cuts or plates be gauged and brought to exact type height of .918". The correct packing thickness, including the sheet to be printed, is .047". These are musts for quality printing, and if overpacking and underpacking is done to compensate for differences, here's what happens:

When cuts or plates are under type height and the cylinder packing is increased more than prescribed thickness to get necessary impression, the surface of the sheet then moves faster than the form because it is the farther away from the cylinder than when packing is normal. This causes a slur. Conversely, when the cuts or plates are above type height and the cylinder is underpacked, the sheet on the cylinder is caused to move fractionally slower than the form.

We cannot emphasize enough the importance of the form and the sheet on the cylinder traveling at the same speed. Make certain that all parts of the form are exactly type high (.918"). If this is done and the prescribed packing thickness of .047" is used, you will

save yourself a lot of time and also insure yourself of a trouble-free job.

If a glossy effect is wanted on absorbent stock, middle-grade linseed oil varnish or a special gloss printing varnish can be added. It should be kept in mind though, that the glossy effect of the printed job depends also on the ink quantity. The more ink, the better the gloss. However, do not over ink.

When printing large solids, the ink should be rather short to prevent picking. Therefore, the printer should use ink paste. Even a small addition will shorten the ink, and the solid areas will have a velvet-like appearance and show no greasy gloss.

As a rule, printing inks are made with only a limited amount of driers in order to prevent the inks from forming skin and drying in the can. The quantity and type of driers to be added by the printer depend on the characteristics of the ink as well as the quality and grade of the paper. Temperature and humidity of the pressroom also affect the drying process. After printing, the first phase of drying is the absorption of the ink by the paper. As a rule, this is a quick process in the case of a short ink. Absorption can be accelerated by adding printing oil or special varnishes.

Fluid driers usually improve the gloss of the print, while drying paste might cause a dull finish. Drying pastes are used to advantage for printing solids. Before starting the run, it is advisable to check the drying qualities of the ink. This, and the amount of drier needed, can be determined by running a few sheets.

Since the amount of printing aids required depends upon various conditions, it is not possible to state exact quantities. One rule, however, is certain: The quantity of printing aids should always be as small as possible. In order to use reducers and driers with safety, it is absolutely necessary to weigh them and to figure percentages required. Careful work will result in good printing.

PACKING ON ORIGINAL HEIDELBERG PLATENS 10x15 AND 12x18

Pre-cut and scored oiled manila top sheets are recommended for use on Heidelberg platens. The top sheet, or tympan, is held on all four sides of the platen by means of the 3 tympan bars and the packing clamp. The amount of packing (.040") can be measured by using the slotted packing gauge on one of the delivery side standards. When packing the press, the bottom bar is put in first, since this bar holds the hanger sheet for makeready.

The balance of the packing is placed under top sheet and the hanger sheet. Then the top sheet is clamped at the top, right hand side, and left hand side - in that sequence.

Positioning the makeready is done by stabbing in the conventional manner. The makeready sheet is then pasted to the hanger

sheet and the loose packing placed over the makeready, thus burying the makeready.

Generally, a hard packing is used as the bulk of jobs consists of type forms. For solids or halftones a softer packing is recommended. In cases of mixed form, a mixed packing can also be used, cutting out the regular sheets and substituting a rubber blanket or newsprint in the areas of the solids. For general job work the packing is comprised of one sheet of .020" pressboard, 50 lb uncoated book and the .006" manila top sheet. The number of sheets of book paper is determined by the thickness of the job being run. For a slightly softer packing, the pressboard can be supplanted by index or tagboard or newsprint for the book paper. The use of a rubber blanket or blotter stock will give a still softer packing, as recommended for solids.

PACKING ON ORIGINAL HEIDELBERG CYLINDERS 21x28

For the OHC the same general principles apply. A recommended packing for general job work consists of the following. Starting from the cylinder 3 sheets of .006" oiled manila for permanent packing with upper sheet reeled to the first draw bar; four or five sheets of 50 lb uncoated book and two sheets of .006" oiled manila with top sheet reeled to second draw bar. The amount of book paper again varies according to the thickness of the job being printed. On the OHC the total packing thickness, including the sheet being printed, is .047". This suggested packing would be considered to be a hard packing suitable for type matter. Variations for a softer packing can be one of the following.

1. Additional sheets of book paper or newsprint in place of manila under the top sheet.
2. One less sheet of manila for permanent packing, balance made up of book paper or newsprint.

3. Press blanket reeled to first draw bar as the top sheet of permanent packing, bearing in mind the press blanket equals two manila sheets in thickness.

All sheets are folded one inch at the gripper edge and held with the tympan clamp. The two sheets being reeled to the draw bars are the only ones extending over the cylinder printing surface. All others must be slightly shorter than the cylinder printing surface.

For positioning the makeready sheet, the press is stopped after the cylinder grippers have closed on the sheet to be made ready, and this sheet is stabbed. The press may be inched until the sheet is most conveniently located for stabbing. After stabbing, the press is started and immediately put on impression. The delivered sheet is now printed and is ready for mark up and overlay.

It is recommended that the makeready be pasted to the bottom sheet of the upper packing, thus burying the makeready and

allowing a second spot sheet to be used over the makeready when necessary. If the press blanket is used it should be

AUTOMATIC STOP

10x15 and 12x18 Original Heidelberg Platens are equipped with an automatic stopping device which consists chiefly of an air cylinder and piston with a regulating screw (see Operation Manual, Page 64). The machine stops automatically if a sheet is not picked up by the feed suckers and will also stop automatically after the last sheet from the feed pile has been picked up and printed. It is necessary to regulate the automatic stop for different types, weights, and sizes of stock. The normal procedure for making the adjustment is as follows:

The regulating screw is backed off as far as possible. Start the press with the sheets being fed. The regulating screw is then turned slowly inward (clockwise) until the press stops. Now again back the regulating screw off, but only one or two turns. The press should now

placed under the top sheet and first manila hanger. All makeready should be under the blanket.

run smoothly if the sheets are being picked up properly by the feed suckers. However, if the press does not stop when the feed table is lowered, thereby interrupting the feed, or if a sheet is not picked up from the pile by the feed suckers, the regulating screws must be turned slightly inward.

If the press continues to stop, even though sheets are being picked up by the suckers, the regulating screw must then be turned slightly outward, or counter-clockwise. It is important to readjust the automatic stop after any stock change because the vacuum in the air cylinder varies in accordance with the weight and size of the paper.

The automatic stop is inoperative when the knob labelled "Pull To Trip Suction" is in the outward position. This permits the press to run, as in the case of running up the ink without sheets being fed.

PRINTING AIDS

Since there is no general ink suitable for all types of jobs and paper stocks, the proper application of printing aids, i. e., reducers and driers, requires thorough consideration. Therefore, the printer should be just as familiar with the characteristics of an ink as he should be with the effects of printing aids at his disposal.

The consistency of printing inks depends on the binding agents used in their manufacture. However, the consistency might change according to the temperature of the pressroom. If the consistency of the ink is not suited to the printing speed, the form and the stock, printing aids must be used.

All of us know that there are liquid reducers, namely printing oils and varnishes, and that

there are paste reducers. The general term "varnish" is used for blending agents which may be variable in regard to their flow and their drying properties. Some varnishes are manufactured of pure linseed oil, while other so-called printing varnishes contain mineral oils plus other ingredients.

Varnishes should be used carefully, as any large addition might seriously affect the ink and entirely change its printing qualities. If an ink has too much tack and tends to pick, an addition of printing oil or a thin varnish will help. If the ink backs up in the ink fountain, a longer grade of varnish should be added. In cases where absorbent stock is being printed, the use of the so-called "printing varnishes" is recommended, because they have better flowing qualities than pure linseed oil varnishes and still insure good drying.

Inks containing mostly printing varnish as a binder will dry with less gloss than inks having a pure linseed oil base. This can be clearly noticed especially in multi-color print-

ing. Linseed oil varnishes are required as reducers for special inks which are used on glassine paper, metal foils, cellophane, celluloid, etc.

PRINTING TWO UP

A device for printing two-up is supplied for both Original Heidelberg platen and cylinder presses as standard equipment. Because there are only a few operations necessary to ready

the press for printing two-up, there is hardly any idle time involved. Please see the Operation Manuals on printing two-up, and also pages 76 and 78 of this book.

SOMETHING IS WRONG HERE!

This is what you will probably say to yourself as you look at this picture and imagine that the pressman is about to start the press. There are four things that must be corrected. In the first place — no, hold it a minute — you'll find more if you turn to page 72.



THIN STOCK

The generally known difficulties in printing thin stocks require very careful adjustments on any machine. At first, we want to deal with the most important adjustments on the 10"x15" and 12"x18" Original Heidelberg. These hints are general and should serve only as a basic guide, because the minute adjustments depend upon the paper, its size, and the ink.

1. Height of feed pile below lower edge of suckers: Top of pile approx. $\frac{3}{8}$ " from lower edge of sucker bar slide.
2. Sucker bar tilt: Generally use plenty of tilt, but there are onionskin papers which can be run better with less tilt or even without any tilt.
3. Paper feed: Paper feed indicator on or near "thin paper" setting.
4. Paper feed (extra lift control): Paper feed indicator on "normal paper".
5. Paper separation: For onionskin and tissue, place pink slide on suckers. All separator springs as far out as possible.
6. Feed air-blast: Cut back air-blast more or less all the way, depending upon paper size and printing speed.
7. Delivery air-blast: Cut back air-blast more or less all the way, depending upon paper size and printing speed.
8. Automatic throw-off: Turn thumb screw counterclockwise.

The following should be observed:

On the feed table, the correct height adjustment of the blower for sheet separation is important. The front separator springs should be as far out as possible, and the side separator springs should extend over the edges of the stock $\frac{1}{8}$ ". It is advisable to bend the ends of the side separator springs downward so that they slightly touch the top sheet of the feed pile.

Feed air-blast for sheet separation should be adjusted only so as to insure that the top sheets are sufficiently separated, but not so much as to blow the paper away from the front lay standard. A sheet slow-down finger should be placed on the tail edge of the pile so that the sheets can be smoothly fed. For light stock we suggest the use of the red sucker bar slide and for onionskin the use of the pink sucker bar slide. Delivery air-blast should be cut back a little. To avoid excessive air-blast for feed and delivery, the air relief valve is opened to reduce pressure.

It is also very important that the grain of the stock runs parallel with the long way of the platen. When printing thin stock with guides, we suggest placing the slide spring next to the left-hand guide. This prevents the sheet from slipping under the guide.

The following adjustments should serve as a basic guide for the 21"x28" Original Heidelberg Cylinder:

1. The clearance between sucker bar and top sheet: Clearance should be approx. $\frac{1}{2}$ ".
2. Sucker bar tilt: Usually use plenty of tilt but there are onionskin papers which can be run better without tilt.
3. Paper feed: Paper feed indicator on or near "thin paper" setting.
4. Paper separation: Place red slides on suckers. All separator springs as far out as possible.
5. Feed air-blast: Cut back air-blast. Blower in top position.
6. Delivery air-blast: (Directly above front edge of delivery pile.) Adjust according to paper size and printing speed.
7. Auxiliary air-blast: This air-blast is produced by a separate motor and serves to facilitate smooth delivery of the sheet. Adjust according to size of sheet and printing speed.
8. Brush: Tension should be light.

PRINTING SOLIDS ON ORIGINAL HEIDELBERG PLATEN PRESSES

The tremendous impressional strength, the excellent cylinder-type inking and hairline register of Heidelberg platen presses permit the printing of a great variety of work within the size range of the press. Quite often we are surprised at the samples which some of our customers send us. They only serve to prove that high quality jobs can be printed on the Heidelberg platen, provided the pressman has some experience and is cognizant of the fact that printing on a platen differs greatly from printing on a cylinder press. Time and time again, we encounter pressmen who feel that no solid of any size can be printed on a platen press. Consequently, they shy away from attempting to print solids on platens.

Actually, solids can be printed on platens, but the technique for doing so must be understood and mastered. First, we will consider the difference between platen and cylinder impression.

In printing on a cylinder press, the sheet is rolled over the form and only a narrow strip is in contact with the form at any one time. On a platen, the printing is done over the whole area and the sheet is peeled from the form in one movement. This is why platen inks must differ from cylinder inks.

Many ink manufacturers have successfully experimented in the development of platen printing inks. Platen inks should have the following qualities:

- a. The ink should be rich in pigment
- b. The ink should be as short as possible

The terms "short" and "long" are very simply defined. An ink is "long" if it extends into a long thread before breaking when drawn between fingers. An ink is "short" if it forms only a short thread before breaking when drawn between fingers.

The most common difficulties which arise when printing solids are picking, mottling and ghosting. However, the slippage of the form rollers and the use of too tacky an ink are also causes of unsatisfactory reproductions. To overcome such printing difficulties, a pressman must first be able to recognize the cause of the problem. This sounds quite simple, but we have seen many cases where pressmen look for troubles in the wrong places. There is a difference in slurs, and pressmen should be able to recognize them quickly. For this reason, we will show five different reproductions of prints. On each of the problems illustrated, we will explain the cause and also give a remedy.

Before going into details, we recommend that pressmen keep this rule in mind:

Use a soft packing when printing solids on platens. We recommend a rubber blanket to be used over the makeready under the draw sheet. The entire composition of the packing should be kept soft and springy through the use of several sheets of newsprint. If a rubber blanket is not available, then use soft blotter stock.

Illustration of Picking

The sheets sticks to the form and the coating of the paper is partially torn off in spots. Picking is caused by an ink that is too tacky. The remedy is to reduce the ink, if possible,

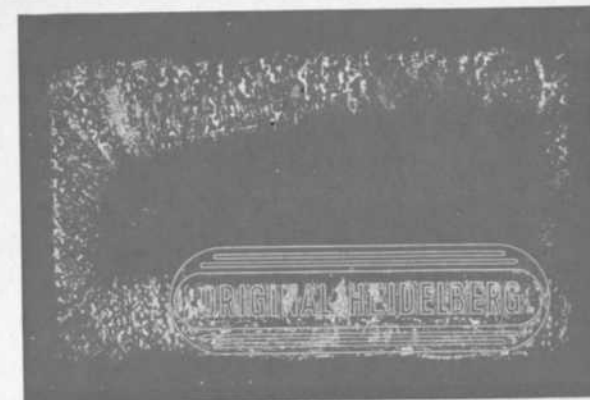

by mixing it with an ink of the same color but of a shorter consistency. It's also wise to check the paper itself, because inferior paper can sometimes cause picking. Your ink supplier can also recommend a suitable paste to shorten the ink. For pressmen who might be in remote areas and do not find supplies available at all times, we recommend the use of rice starch.

Illustration of Mottling

In this case, the ink resembles tiny bubbles which have burst and dried. A close examination will show that impressional tension has separated the ink pigments from the binding agent (varnish). The ink is too thin and should be thickened with rice flour, starch or other recommended agents. Avoid using anything which would tend to make the ink thinner.

Illustration of Slur Caused when Ink is Too Tacky

In platen press printing, a slur will result when the paper sticks to the form after printing and as it is pulled away by the gripper. The sheet is pulled sideways, causing a slur. This comes from using an ink that is too tacky. The remedy is to reduce the ink, if possible, by mixing it with an ink of the same color, but of shorter consistency. The use of a frisket finger will help to eliminate this difficulty.

Illustration of Slipping of Rollers

This type of slur is very often confused with ghosting. Ghost marks appear only after the form rollers have "unrolled" the second time. Roller slipping or skidding show up in the shape of a narrow strip when rollers reverse at the bottom of the form. When the form rollers skid during the reverse movement, the image of the form made during the downward stroke will not match its likeness on the upward stroke. Thus, a "ghost" results.

Form rollers on Heidelberg platens are equipped with ball bearings so as to prevent skidding as much as possible. It is very important that roller trucks and roller tracks be kept free from grease and oil.

Sometimes improper setting of a rider roller will also cause form rollers to skid or slip. When the rider is set too tightly, the lower form roller is caused to lift slightly on the return stroke. Thus, when the upward and downward strokes do not correspond, "ghosts" will appear.

Illustration of Ghosting (Repeat Marks)

In letterpress printing, the form inking depends upon the "circumference-unrolling" of ink from form rollers onto the form. Cut-outs in the plate or reverse forms do not take any ink from the form rollers, and this leaves a heavier film of ink on the rollers.

During the next downward stroke of the form rollers, this excess ink is transferred to the plate and causes a darker tone on the paper.

This is a so-called "repeat" mark. As can be seen in the illustration, the line of type in front of the full solid takes ink off the form roller. After the solid has been inked and one turn of the form roller completed, an image of the line of type appears in the solid due to a lack of ink.

"Ghosting" also can appear in the form of streaks (see diagram below). To minimize "ghosting", heavy-bodied inks should be used. Never lighten them with transparent white alone. Better results can be obtained by using a base white or a mixture of 50% zinc white and 50% transparent white. Today most ink companies supply inks that have the qualities required for best results in platen press printing. When ordering inks, specify whether they are to be used for halftones or solids.

Adjust the fountain blade so that only a thin film of ink is transferred to the ductor roller. Try to obtain the correct supply of ink with as long a fountain stroke as possible.

Adjust the rider roller in such a way that it touches only the lower form roller. This insures better inking because the lower roller receives an additional ink supply from the rider roller during the upward stroke.



Slipping of Rollers

Illustration Diagrams (see next page)

Illustrations 1 and 2 clearly show that a heavy film of ink has been transferred from the plate to the left side of the paper. After the form rollers have "unrolled", the next film of ink is thinner. Similarly, the ink transferred from the plate to the paper is not as heavy as it was before.

Illustration No. 1 shows how the light beam is reflected on the surface when inks containing opaque pigments are used. Illustration No. 2 shows that the light beam will penetrate through the ink film to the paper when transparent ink is used.

This shows that the white of the paper is much more visible through a thin film of ink, and that the ink itself appears lighter. The illustration clearly shows that inking problems can be overcome to a great extent by using inks that are strong in body and density.

Mottling

Slur Caused when Ink is Too Tacky

Ghosting (Repeat Marks)

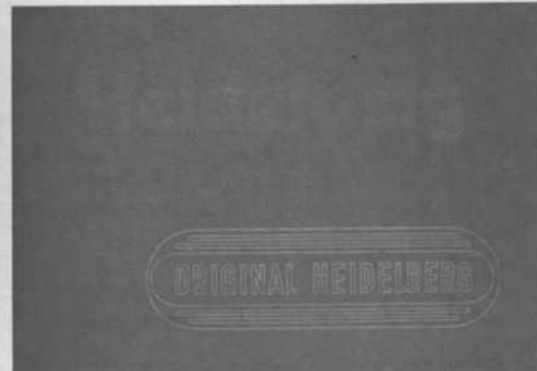
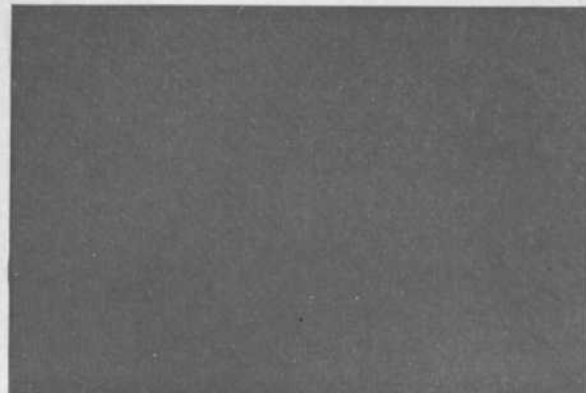

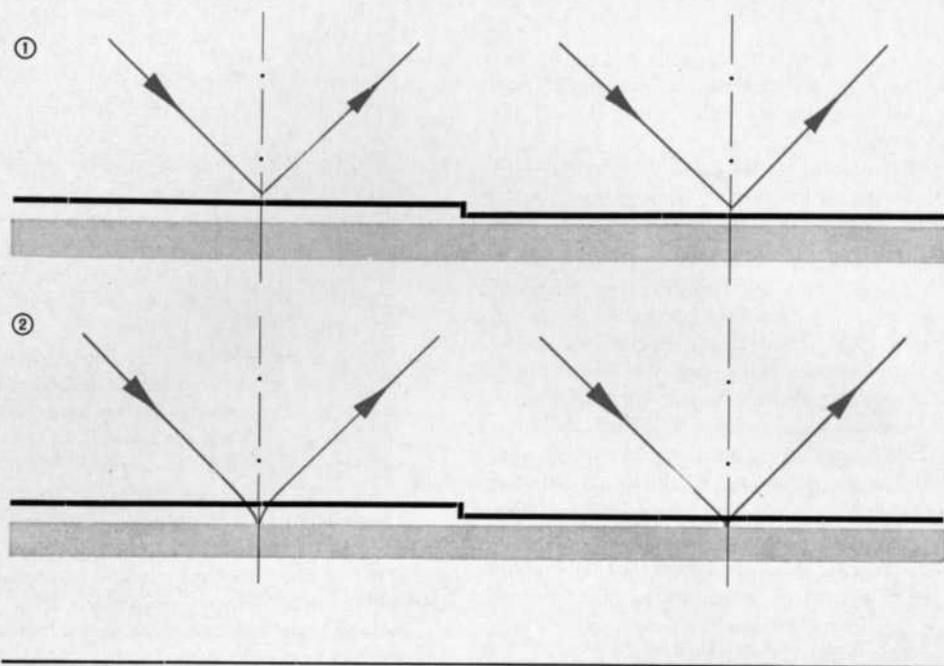

SOLUTION TO "QUIZ" ON PAGE 67

The four things "forgotten" by the pressman are:

1. In the bottom left of the picture, an Allen Wrench is lying on the type bed.
2. The right-hand chase lock is not secured (here serious damage would be prevented by the automatic safety device).
3. There is a Quoin Key on the form.
4. There are two Reglets on the right-hand bed bearer.

In actual production, a pressman will seldom disregard four different items when starting his machine. In one picture we showed the four most common ways in which machines are often damaged. In publishing this, we hope that it serves as a reminder against carelessness. The operation of the Original Heidelberg Cylinder is very simple, and its single-lever system automatically prevents operational errors. However, there is no security against carelessness. It is similar to automobile traffic. Traffic lights, warning signs and pedestrian crosswalks increase the margin of safety - it is minimized whenever an operator is careless or reckless.

SOLUTION TO "QUIZ" ON PAGE 27

Here is a brief review of the 8 questions asked and the correct answers:

- 1 Do you use a hard packing to print large solids and halftones on Original Heidelberg platens?
NO. A soft packing is more advantageous. Makeready should be buried as deep as possible and covered with a rubber blanket or blotter stock.
- 2 When printing halftones on our platen presses, can you use the same ink you would use on cylinder presses?
NO. For the 10"x15" and 12"x18" Original Heidelbergs, a short-bodied ink rich in pigment, should be used. A short-bodied ink can be recognized when, taken up on the ink knife, it will break off short. Ink houses today furnish inks for our platen presses which can be used straight from the can. When ordering inks, always specify press on which job is to be run.
- 3 When pulling an impression, and you find that the impression is heavier at the top than the bottom, do you increase your packing thickness by inserting one or more sheets?
YES. To obtain even printing, you should increase the packing and decrease impression. Of course, if the impression is heavier at the bottom than at the top, you should take out one or more sheets and increase impression.
- 4 When printing solids and a slur-caused by the ink-appears, do you dilute your ink by adding boiled linseed oil?
NO. You should make the ink stiffer by adding some paste reducer or powdered starch.
- 5 Do you use composition rollers in order to eliminate ghosting?
NO. Rubber rollers are better because their surface can carry more ink than composition rollers. This ability to carry more ink will help to eliminate ghosting.
- 6 Can you get a quality print with gold ink directly on dull enamelled stock?
NO. Dull stock requires an ink base when printing gold ink. Special ink bases are available for this purpose. You can also substitute by using yellow inks as a base.
- 7 When printing a heavy form and the machine stops with the platen on impression, do you try to get the press off impression by turning the flywheel backwards?
NO. When the press is engaged, the flywheel should not be turned backwards because serious damage to the control mechanism of the gripper system may occur. That is why the machine is equipped with a reverse safety device which automatically prevents the machine from being turned backwards.

First, check to see if the clutch is slipping. If so, turn both clutch adjusting screws to the right by 1/3 of a turn. If this and turning the flywheel forward does not release the press, lift safety device between base and flywheel with a screwdriver while rocking flywheel back and forth lightly. After safety device becomes disengaged, turn flywheel backwards not more than 6 inches. The impression backwards can then be released.
- 8 When washing up the press, is the following sequence correct?
a) Start press
b) Engage wash-up blade
c) Apply wash-up fluid
NO. Only after the roller cleaning fluid has been applied should the washup blade be engaged.

SOLUTION TO "QUIZ" ON PAGE 51

Here is the review of the eight questions with our detailed answers:

- 1** When printing a halftone, you find that the dot is slurred towards the tail edge of the sheet. Do you reduce the cylinder packing by one sheet which you lay under the cut?
YES. If the cut (halftone block) is too low, the cylinder packing would be increased to get the necessary impression. The result is that the sheet on the cylinder moves fractionally faster than the form on the bed. The screen dot is elongated and points toward the tail edge of the sheet. Conversely, if the cut is too high, the cylinder would have to be underpacked because distortion occurs and the elongated dot points toward the gripper edge of the sheet.
- 2** The rubber rollers are encrusted with ink. Since the roller washing fluid does not clean the rollers, do you try to remove the ink crust by rubbing the rollers with type cleaner?
NO. In case ink or varnish leaves a glazed surface on the rubber rollers, a regeneration paste (Rollopaste, which can be supplied by your Heidelberg dealer) should be applied to the surface of the rollers and left to set overnight. Next morning, they are easily cleaned with lukewarm water, leaving a velvet-like surface. Be careful in using gasoline, type cleaner or so-called ink eradicators since these are highly volatile and will impair the roller.
- 3** In using die-cutting rule on the Original Heidelberg Cylinder, should it be somewhat over type-high?
NO. The die-cutting rule must be type-high.
- 4** When printing a solid, the ink picks. Do you try to eliminate this problem by adding reducer?
YES. The best remedy against picking is the addition of reducer.
- 5** It is correct to fill the oil gun with grease for use on the points provided with lubricating nipples?
NO. Do not use grease. It has a tendency to resinate and does not possess the high lubricant qualities of a high-viscosity oil.
- 6** When starting the press up on a register job, the first sheet through the press does not register. Does this mean something is wrong in the sheet transfer mechanism?
NO. If the first sheet is out of register, the impression was thrown on too late. Impression must be thrown on the moment the transfer grippers have closed on the registered sheet — that is, before the sheet has been transferred to the cylinder grippers. If the impression is thrown on too soon, an impression will appear on the packing.
- 7** When printing cardboard, should the grain run the short way of the cylinder?
NO. The grain of cardboard should run the long way of the cylinder. The sheets then can hug the cylinder, and higher printing speeds can be obtained.
- 8** When printing an ordinary type form, can you remove the third and fourth form rollers and produce this job with two form rollers?
YES. Ordinary forms can be run with two form rollers. Three or four form rollers add considerably to the quality of printing on large solids and halftones.

STATIC ELECTRICITY

From feed to delivery, static electricity can cause serious difficulties. There are many possible ways to eliminate static electricity. Most of them, however, are expensive and not 100% effective. What we mean are the ionizers, copper brushes and other aids, most of which are self-made. The cheapest, simplest and most reliable remedy is to insure that temperature and humidity in the print shop are kept constant. Moreover, paper should always be stored under identical conditions or should be allowed, prior to printing, to acclimatize itself to the pressroom atmospheric condition. Print shops equipped with air conditioning hardly ever encounter difficulties with static electricity. We recommend a humidity control unit for print shops lacking air conditioning. Maintaining constant temperature and humidity throughout all seasons is of the greatest importance. The most favorable climatic pressroom conditions will be found when the temperature is 70–80° F. and the humidity is 60–70% relatively. On jobs not requiring the spray gun, the printer can overcome static by the use of an inexpensive expedient. He fills the spray gun on his Heidelberg with water and atomizes

it in front of the feed pile. When the spray gun is in use, simply place a wet rag over the air filter of pump. The moisture will then be injected into the feed pile through the feed air blast holes for sheet separation. After the run is completed, it is advisable to clean and apply an oil film to bare metal parts. Various firms manufacture so-called static electricity eliminators. There are also liquids which are rubbed over the packing, the grippers, etc., and they tend to reduce static electricity somewhat. Glycerine, too, often serves the same purpose.

One other method to reduce static electricity is the use of a tin foil or aluminum foil tympan. Constant temperature and humidity is, as mentioned previously, one of the surest means to overcome static electricity. Even temperature and humidity should also be maintained during holidays and weekends, because fluctuations during this time may cause static electricity. Every printer should always keep in mind that the cost of controlling pressroom atmosphere will be much lower than the cost of a job spoiled by static electricity and resultant loss of time.

EXTRA ACCESSORIES FOR SPECIALTY WORK

Through our close contact with printers all over the world, we have developed a number of extra accessories for our customers. These meet the demands of specific job situations and enable printers to broaden the range of their job work. These accessories have often helped to secure new printing orders and new customers. It is not our intention to make specialty machines out of Heidelbergs with these accessories, for they only serve the purpose of enabling owners to accept unusual jobs without having to purchase special machines.



Tilting Feed Table Device for Printing Paper Bags that Pile Unequally on One Side

This device always keeps the slant of the feed table correct. The top sheet (in this case the top bag) always lies smooth and even so that it can be picked up by the suckers and taken by the gripper without difficulty. This device is designed for printing two-up. Another accessory, available only for the 10x15 Original Heidelberg, makes it possible to print stock that piles up unevenly on two sides.

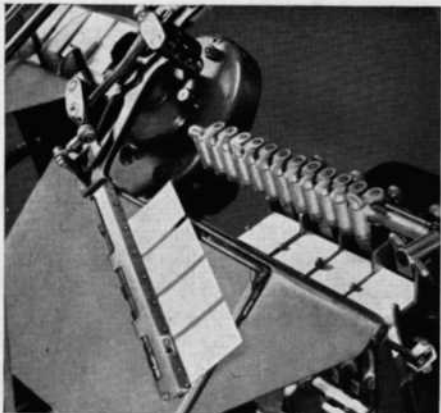

Accessory for Printing Small Sizes Three- and Four-Up (Tags, bags, labels, etc.)

This device consists of a special feed and delivery table and side standards. On the 10x15, the minimum size that can be printed four-up is $1\frac{3}{16}'' \times 1\frac{1}{2}''$. On the 12x18 Original Heidelberg, the minimum size that can be printed four-up is $1\frac{1}{2}'' \times 4''$.

Accessory for Printing Circular and Oval Disks

This is designed for two-up printing of disks with diameters of $1\frac{1}{2}''$ to $4\frac{3}{4}''$. The thickness of the stock should not exceed 8-ply.

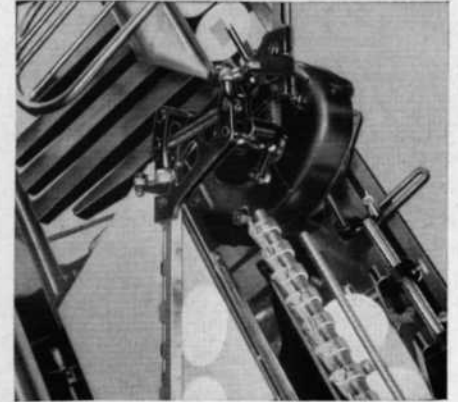

Accessory for Printing Open Cut-out Envelopes With and Without Guides

This extra accessory consists of a special feed table with round side standards. It enables the printing of open cut-out envelopes and other angled stocks with and without guides. Since different types of guides are required, we recommend that stock samples be submitted when considering this extra accessory.

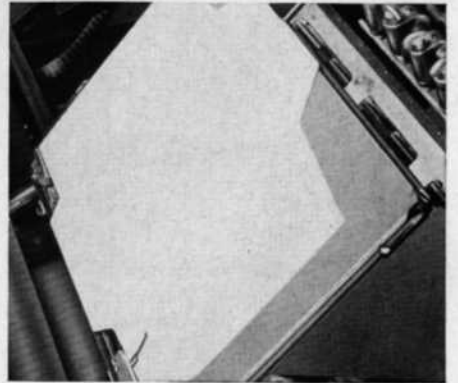

Accessory for Printing Slightly Curved Sheets Without Register Guides

Special feed and delivery tables have been developed to handle slightly curved sheets that are to be printed without guides. If a job with curved stock requires close register, special guides are available to match the form of curved stock.

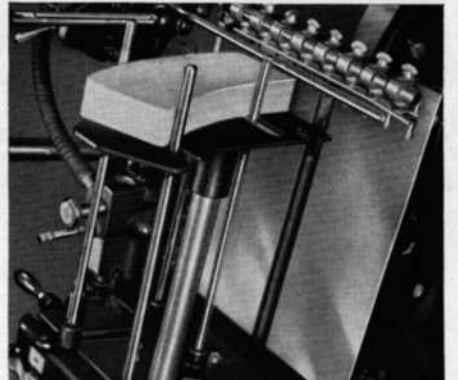

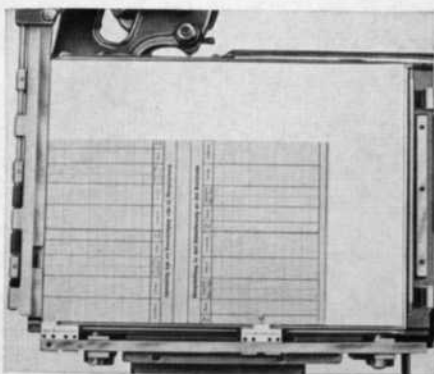

Bottom Register Guides for Printing Without Paper Margin

These special guides are used when printing bookkeeping forms, file cards, etc., where type matter or rules must be printed right up to the edge of the sheet. This accessory is available only for the 10x15 Original Heidelberg.



Accessory for Printing Odd Shaped Stock Two-Up

This accessory is recommended when a plant has long repeat orders on odd-shaped labels or similar stocks. It consists primarily of special feed and delivery tables and round side standards. This is available only for the 10x15 Original Heidelberg.

Please avail yourself to Heidelberg's customer service in case you want more information on such specialty work.

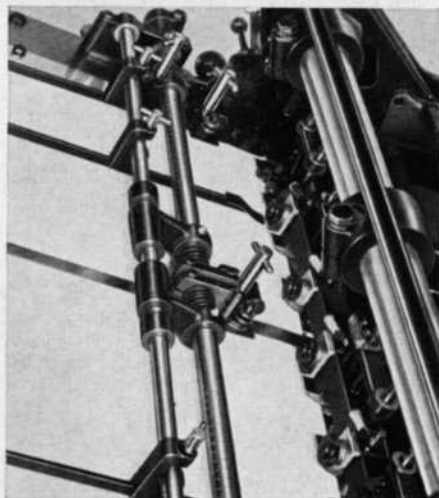

Device for Printing Two-Up

A device for printing two-up is furnished with the machine. This enables two sheets to be printed at the same time, thus doubling output on smaller sizes. Two different jobs can be printed at the same time if the sheets are of the same thickness. No alteration of standard equipment is necessary to print two-up. It's simply a matter of adding a few pieces to feed and delivery.

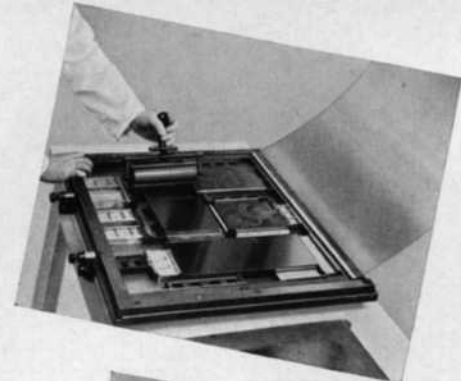

Device for Pre-Registering Forms

Furnished with the 21"x28" Original Heidelberg Cylinder is this device for pre-registering forms in the chase on the stone. On multi-color jobs, the plates or type can now be completely positioned in the composing room with the greatest accuracy by using this speedy form positioner. It's quick and simple to use, decreases down-time of press, increases production and profit.

The first illustration shows our speedy form positioner.

The hinged portion is inserted with its two guide pins into the chase.

After the form has been locked and positioned for the first color, the form is adequately inked. Then, the transparent sheet is placed upon the form (shown in the second illustration). An image of the form is obtained by strongly rubbing over the transparent sheet with the heel of the hand.

As shown in illustration No. 3, the pressman should make certain that he has all the necessary details which will be required later on for positioning succeeding forms.

Illustration No. 4 shows how the plates and the type for the second color, and if applicable, the third or fourth color can be positioned precisely and locked up from the image of the first form.

Also available for the 21"x28" Original Heidelberg Cylinder as an extra accessory is a composing stone equipped with chase stops, chase locks and side bearers, making it an exact replica of the type bed of the press. This composing stone makes it possible to lock up the form in the composing room just as it would be on the bed of the press. Since this stone makes it impossible to distort the chase when locking up, a complete lock-up with "final proof" accuracy is obtained. (Also refer to page 59.)



TOPICAL INDEX

Abbreviations: P = Original Heidelberg Platens
OHC = Original Heidelberg Cylinder

A			
Accessories, extra	76	Ghost marks P	28
Adhesive foils	13	Gloss inks	57
Adjusting printing plates	9, 30, 39	Gloss stock	57
Adjusting rollers P	11	Gold ink printing	56
Air humidity	14, 30	Grain of paper	30
Air temperature	14, 30		
Anti-offset spray	31, 63	H	
Automatic stop	66	Halftone printing OHC	30, 31
		Halftone printing P	9
B		Hand cut-out	32, 52
Bases for mounting plates	41	Heating device for ink fountain OHC	40
Blind embossing	18	Heating device for ink fountain P	22
Blind printing line	62	Heidelberg printing blanket OHC	65
		High-gloss inks	57
C		High-gloss stock	57
Carbon ink printing OHC	40	Hot embossing OHC	39
Carbon ink printing P	22	Humidity	14, 30
Checking correct height of plates	41		
Composition of packing	65	I	
		Ink for halftone printing P	10
D		Ink for solid printing P	12
Device for registering forms	59, 79	Ink refusing to take	63
Die-cutting OHC	33	Ink slur OHC	43
Die-cutting P	15	Ink slur P	25
Double-sided adhesive tape	13		
Driers	66	K	
		Kastoline	63
E			
Embossing OHC	30	L	
Embossing P	19	Linseed oil varnish	66
Extra accessories	76	Locking up multi-color plates	31
F		M	
Fastening of printing plates	13, 31	Makeready for die-cutting P	15
Female die	18, 33	Makeready for halftone forms P	9
Form positioning device OHC	79	Makeready for mixed forms P	8
Form positioning device P	59	Makeready for process	
Form preparation	59	color printing OHC	32
		Makeready for process	
G		color printing P	13
Gauge, type-high	41		
Ghosting on platen presses	28, 69		

Makeready for solid printing	12
Male die	19, 39
Manila sheets	8
Maximum load for die-cutting P	16
Mechanical makeready systems	54, 55
Mixed forms P	8
Mottling of ink	12, 63, 69
Mounting bases for plates	13
Multiple printing	76

N	
Normal inks P	13, 14
Numbering OHC	36
Numbering P	24

O	
Offset of printed sheets	63

P	
Packing composition	65
Packing for halftone printing P	9
Packing for mixed forms P	8
Packing for multi-color printing OHC	31
Packing for multi-color printing P	13
Packing for solids P	12
Packing thickness	64
Pastes	66
Picking	12, 66, 69
"Pivoting" when locking up form	13, 31
Plate mounting	13
Plate slur OHC	44
Plunger numbering boxes	24, 36
Pressroom temperature	14, 30
Pressroom safety	61
Primaton makeready	55
Printing aids	66
Printing of halftones P	9
Printing of mixed forms P	8
Printing of multi-color	
process jobs OHC	30
Printing of multi-color	
process jobs P	13
Printing of solids P	12
Printing two-up	67, 76, 78
Process-color printing OHC	30
Process-color printing P	13
Profitable die-cutting	15, 33
Profitable embossing	19, 38

Q	
Quiz questions for the	
cylinder pressman	51
Quiz questions for the	
platen pressman	27

R	
Reducers	66
Register differences on 1st sheet OHC	74
Repeats OHC	44
Repeat marks on platen presses	28, 69
Rider roller P	63
Roller marks P	28
Roller slipping	70
Roller slur OHC	44
Roller slur P	25
Roller treatment	58, 59
Roller washing solvents	58, 59
Rollopaste	74
Rubber blanket P	8
Rubber rollers	58
Rules, steel cutting	15, 33

S	
Safety, pressroom	61
Screen of plates for process printing	14
Sequence of inks	13, 30
Sheets sticking to the form	13
Slurs OHC	31, 63
Slurs P	25
Slur when ink is too tacky OHC	44
Slur when ink is too tacky P	26, 69
Solid printing P	12, 69
Specifications	82, 87
Spot work	32, 52
Squeeze marks P	28
Stacking the run	32
Static electricity	75
Stop, automatic	66

T	
Tape, double-sided adhesive	13
Temperature, pressroom	14, 30
Thin stock	68
Top sheet OHC	50
Treatment of rubber rollers	58
Tympan sheets	8
Type-high gauge	41

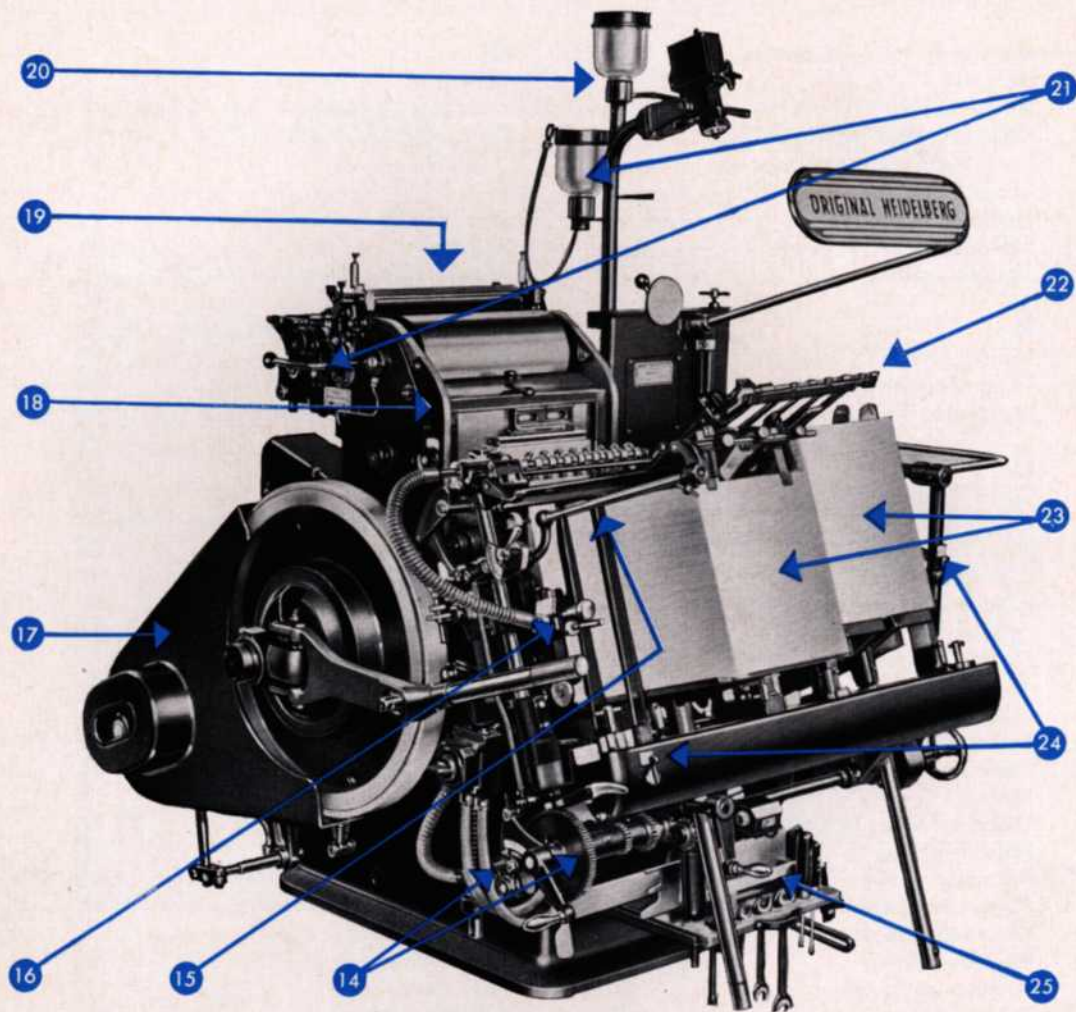

10x15" ORIGINAL HEIDELBERG PLATEN

- | | |
|---|--|
| 1. Ease of operation | 7. Single stroke air pump |
| 2. Fastest platen press in the world
Maximum printing speed:
5,000 IPH
10,000 IPH when printing two-up | 8. Dual air pump valves |
| 3. Toggle lever drive | 9. "Save-a-step" press stop |
| 4. Overload safety | 10. Speedy form positioner |
| 5. 40 tons impression strength | 11. Precision ground type bed surface |
| 6. Multiple printing | 12. Precision ground platen surface |
| | 13. Ball bearings at all vital points |
| | 14. Wide range feed table lift control |
| | 15. Heidelberg built-in feeder |

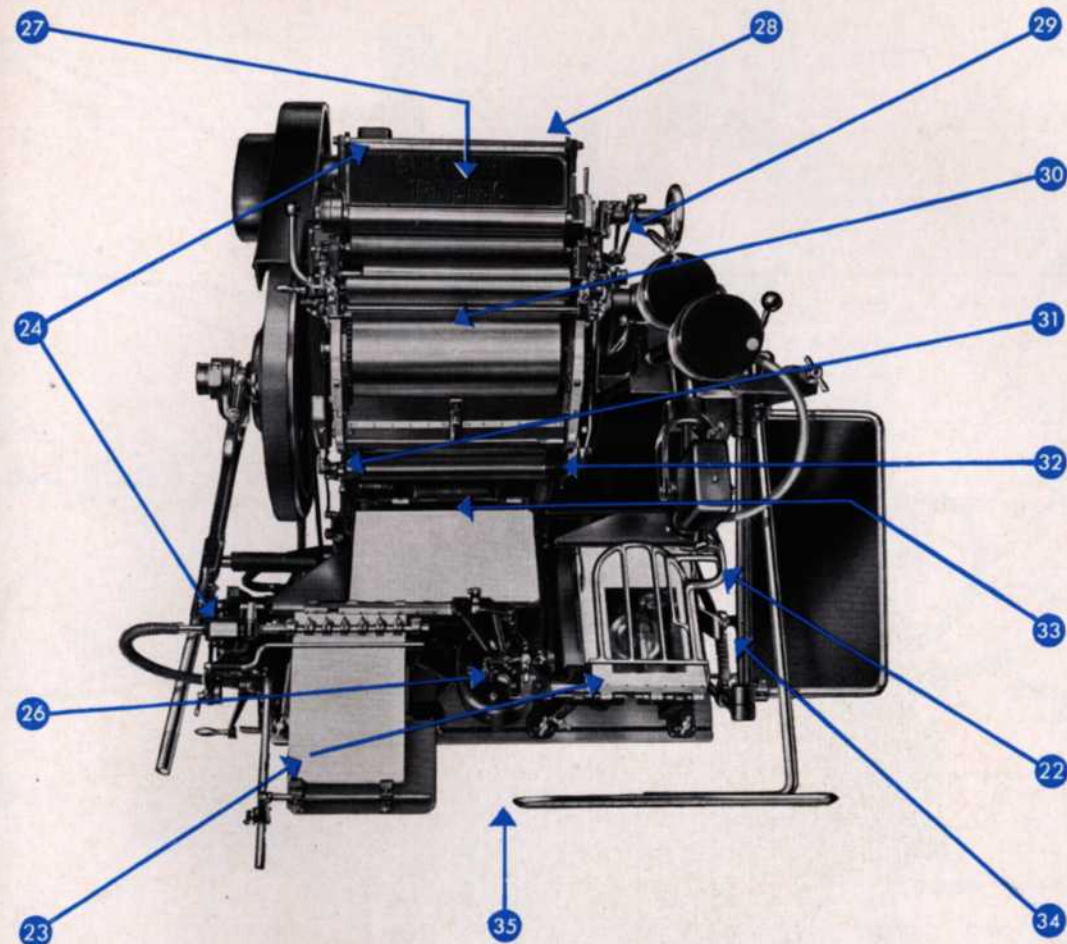

- | | |
|---|--|
| 16. Automatic press stop | 26. Rotary gripper system, a Heidelberg principle
80,000 times approved |
| 17. Streamlined flywheel and pulley guard | 27. Drop-blade fountain |
| 18. Adjustable roller tracks | 28. Central "one-shot" lubrication |
| 19. Fountain key tension band | 29. Automatic fountain trip |
| 20. Built-in spray gun | 30. Cylinder type inking |
| 21. Built-in roller washup | 31. Disengaging form rollers |
| 22. Aerodynamic controlled sheet delivery | 32. Form rollers equipped with ball bearings |
| 23. 13" Flat feed and delivery capacity | 33. Hairline register guides |
| 24. Instruction plates and scales at all operating points | 34. Automatic sheet jogger |
| 25. Positive wide-range speed control | 35. Single lever impression control |

TECHNICAL DATA:

Largest sheet size	10 1/4" x 15"
Smallest sheet size	1 1/2" x 2 1/4"
Inside chase measurement	10 1/4" x 13 3/4"
Inside chase measurement, skeleton chase	10 1/4" x 13 3/4"
Floor space required	5'3" x 3'8"
Power required	1.5 HP
Net weight, approximately	2,300 lbs.

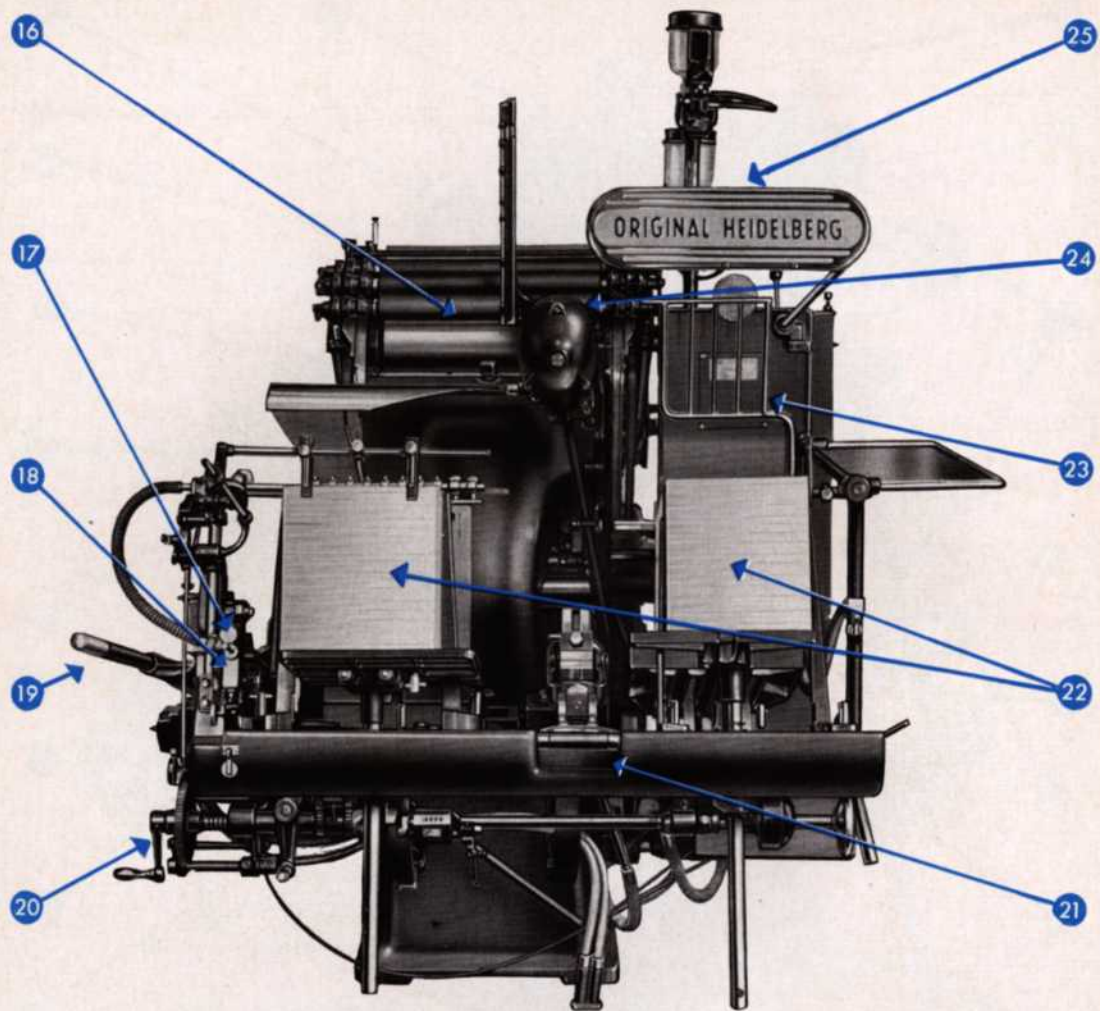

12x18" ORIGINAL HEIDELBERG PLATEN

- | | |
|--|---|
| 1. Hairline register guides | 11. Streamlined flywheel and pulley guard |
| 2. Maximum speed:
4,000 IPH
8,000 IPH when printing two-up | 12. Speedy form positioner |
| 3. Toggle lever drive | 13. Precision ground type bed surface |
| 4. Overload safety | 14. Precision ground platen surface |
| 5. 60 tons impression strength | 15. Ball bearings at all vital points |
| 6. Multiple printing | 16. Cylinder type inking |
| 7. Drop-blade fountain | 17. Automatic press stop |
| 8. Fountain key tension band | 18. Instruction plates and scales at all operating points |
| 9. Automatic fountain trip | 19. Simplicity of operation |
| 10. Adjustable roller tracks | 20. Wide range feed table lift control |
| | 21. Single lever impression control |
| | 22. 13" Flat feed and delivery capacity |

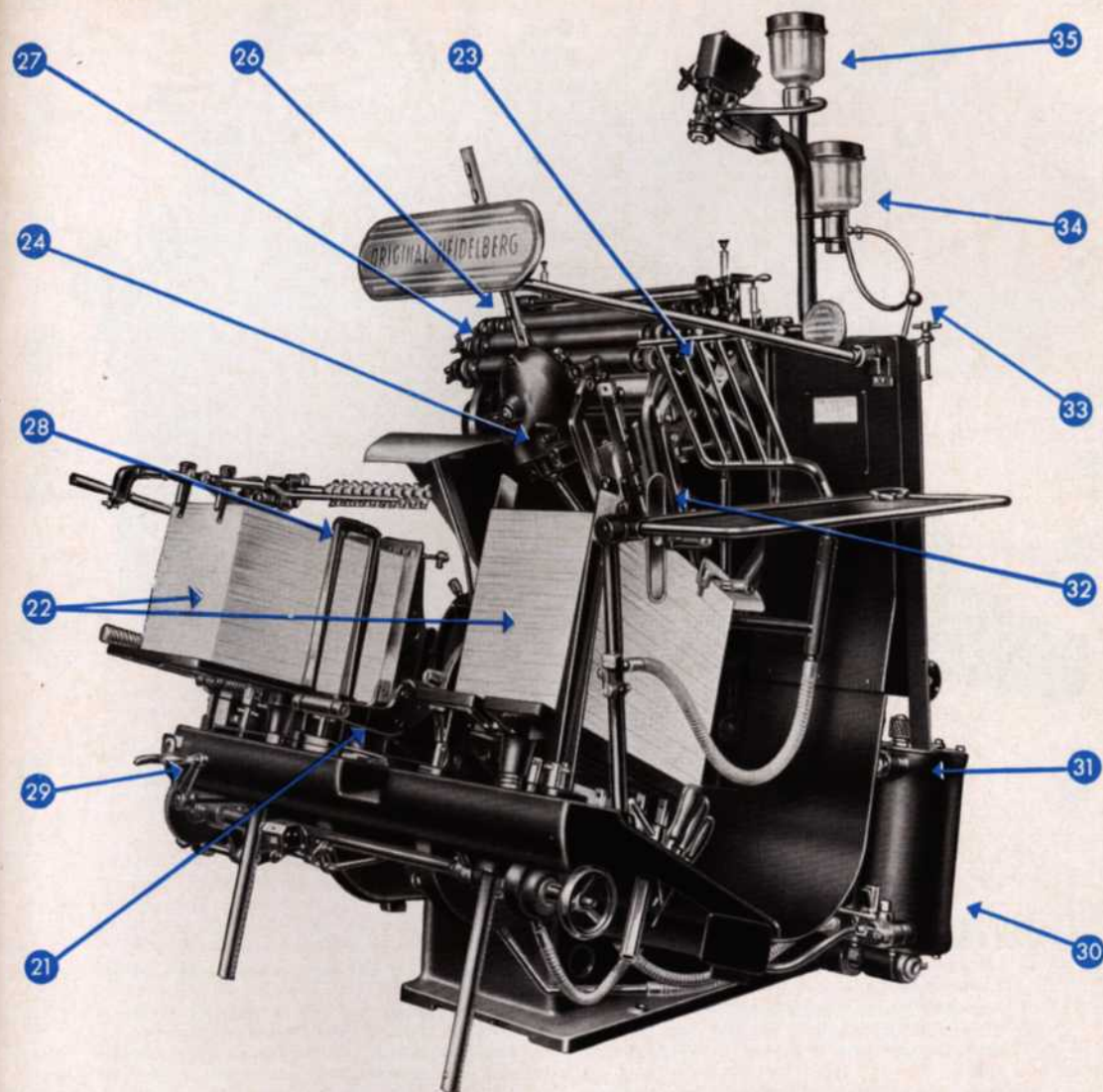

- | | |
|--|---------------------------------------|
| 23. Aerodynamic sheet delivery | 29. Positive wide-range speed control |
| 24. Rotary gripper system, a Heidelberg principle
80,000 times approved | 30. Single stroke air pump |
| 25. Central "one-shot" lubrication | 31. Dual air pump valves |
| 26. Form rollers equipped with ball bearings | 32. Automatic sheet jogger |
| 27. Disengaging form rollers | 33. "Save-a-step" press stop |
| 28. Heidelberg built-in feeder | 34. Built-in roller washup |
| | 35. Built-in spray gun |

TECHNICAL DATA:

Largest sheet size	13 3/4" x 18 1/4"
Smallest sheet size	3 1/2" x 4"
Inside chase measurement	12 1/2" x 17 1/4"
Floor space required	4'7" x 6'6"
Power required	2 HP
Net weight, approximately	4,950 lbs.

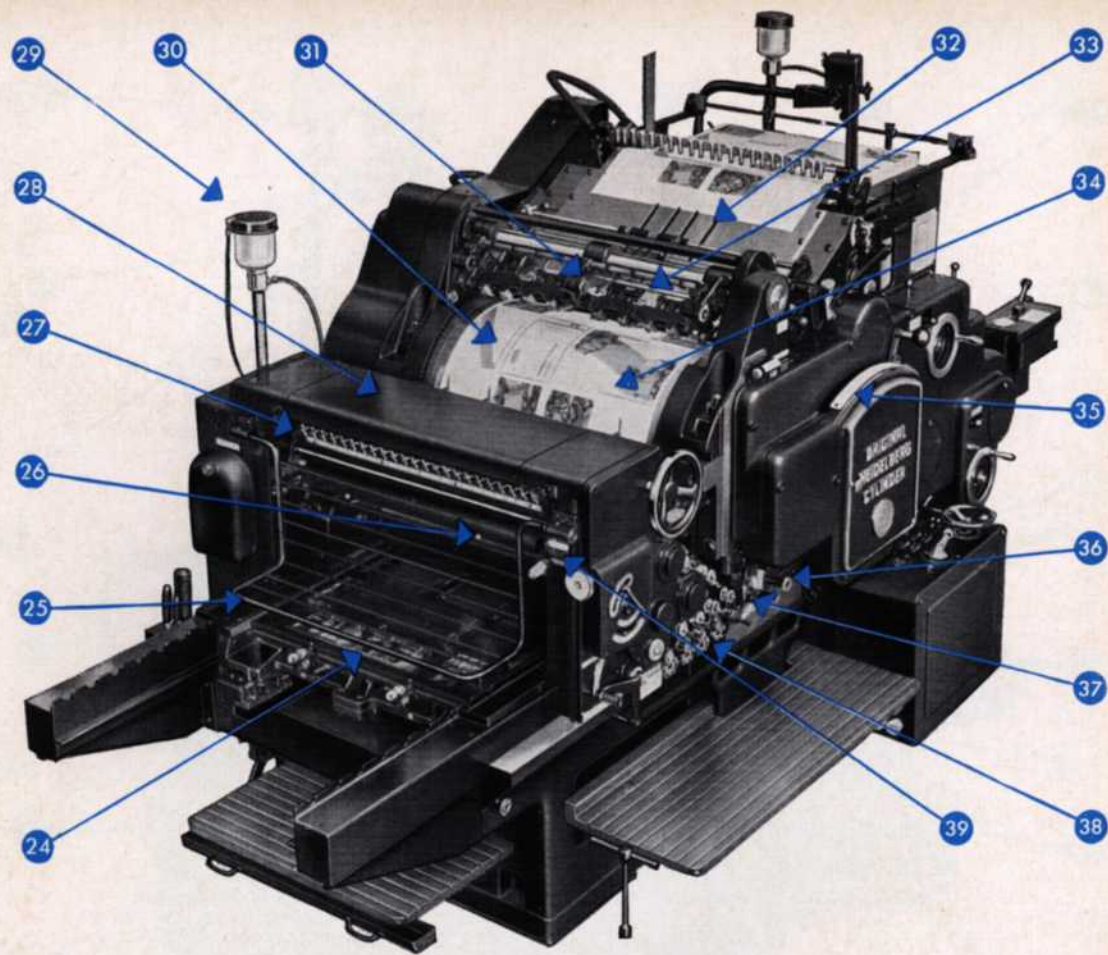

21x28" ORIGINAL HEIDELBERG CYLINDER

1. The years-ahead engineering with rotary efficiency — a new principle
2. Practical production speeds up to 4,000 IPH
3. A complete printing unit, self-contained, with no swing-aways or parts to be removed for full accessibility
4. 4 1/4" cylinder journals running in journal boxes that are rigidly locked on impression throughout the entire printing stroke
5. Precision ground type bed and cylinder
6. Packing clamp and cylinder grippers in one assembly, easy to operate by a handwheel, requiring no tools
7. Extra two-sheet caliper for running two-up
8. Corresponding scales on the ink fountain and the delivery for correct regulation of ink flow
9. Convenient to stop press from various locations
10. Six areas of support for type bed
11. One-piece, box-type, torsion-free base
12. Corresponding scales on the feed table, side guides and on the chases to simplify the speed of positioning
13. Press automatically shuts off when the last sheet is fed
14. Built-in delivery air control, enabling high production speeds
15. Compact design occupies small area, results in top production per unit to floor space
16. Rigid construction providing impression strength to accommodate the heaviest possible forms
17. Sheets are fed and delivered without rollers or tapes. Positive gripper control with all grippers self-contained for size and weight of stock
18. Total weight of 10,350 lbs. of precision engineering
19. Main gears operating in oil bath
20. Pre-registering device for multi-color work, reduces down time
21. Sturdy, completely vibration free construction
22. Hairline register is assured not only under varying speeds, but also when printing different colors or portions of the same job on other Heidelberg Cylinders
23. Complete versatility of sheet size, plus versatility of die-cutting, creasing, embossing, numbering and perforating
24. Type bed easily accessible at all times for working on form, convenient without swing-away

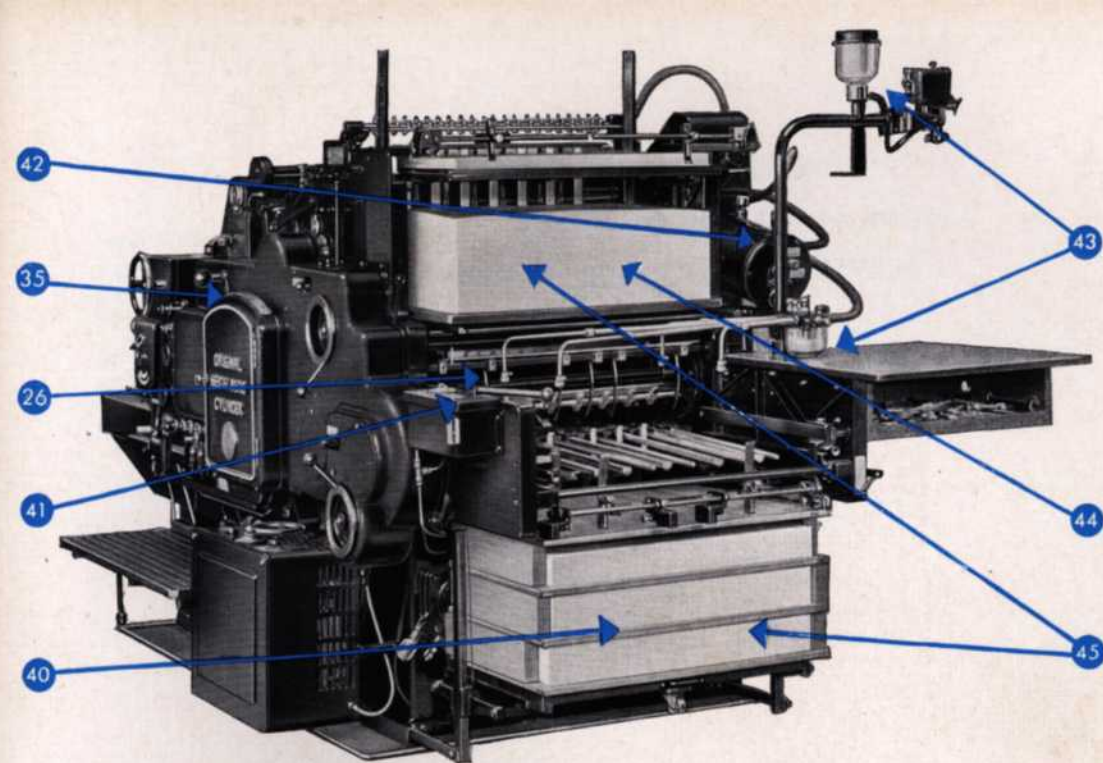

25. Form and roller guards
26. Fluorescent lighting over form and delivery
27. A drop-away ink fountain with 23 fine adjusting screws
28. A precisely controlled inking system allowing maximum adjustments to meet the requirements of form, ink, paper and printing speed
29. Built-in automatic roller washing device, washing all rollers and the form
30. A large diameter, single revolution impression cylinder, convenient at all times for rapid makeready
31. Additional side standards and register facilities for the added versatility of running work two-up
32. Four traveling feed board grippers that require no adjustment for size or weight of stock, and eliminate all tapes, feed-rolls, or other frictional devices
33. Precisely engineered transfer device, assuring hair-line register irrespective of changing speeds
34. A 21" diameter impression cylinder weighing one ton
35. Single-lever control — all operations in proper sequence from one control
36. Bearer pressure control for light, medium or heavy forms
37. Convenient cylinder brush easily adjusted to the requirement of the job and easily removed for cleaning, designed to prevent dust and lint from falling on the form
38. Pyramid inking system with four form rollers
39. Automatic trip of ink supply when impression is off
40. Device for continuous delivery
41. Single-lever, high pressure control lubrication
42. Paper dust and spray filters on air pump
43. Both wet and dry spray furnished as standard equipment, with built-in compressor, to meet the specific requirements of every job
44. Preloading device furnished as standard equipment
45. Convenient feed and delivery piles with no swing-aways

TECHNICAL DATA:

Largest sheet size	21 1/4" x 28 1/4"
Smallest sheet size	4 1/2" x 6 1/4"
Maximum form:	
in standard chase	20 1/4" x 27 1/4"
in skeleton chase	20 1/4" x 28"
locked on bed	20 1/4" x 28"
Floor space required	11'2 1/4" x 6'3"
Power required	6.5 HP
Net weight	10,350 lbs

15x20 1/2" ORIGINAL HEIDELBERG CYLINDER

**COAST-TO-COAST
BEFORE AND AFTER-SALES
SERVICE IN THE U.S.A.**

Distributors:

Heidelberg Eastern, Inc.
Distributor of Heidelberg Automatic Presses,
73-45 Woodhaven Blvd., Glendale 27, L.I., N.Y.
2015 S. Michigan Avenue, Chicago 16, Illinois
3501 Detroit Avenue, Cleveland 13, Ohio

Heidelberg Southern Sales Company
Distributor of Heidelberg Automatic Presses,
6319 Eppes Street, P.O. Box 12301,
Houston 17, Texas

Heidelberg Pacific, Inc.
Distributor of Heidelberg Automatic Presses,
1700 South Wall Street, Los Angeles 15,
California

Dealers:

A. E. Heinsohn
Printing Machinery & Supplies
Dealer for Heidelberg Automatic Presses
1443 Blake Street, Denver 2, Colorado
246 West 1st South St., Salt Lake City, Utah
1828 W. Jefferson St., Phoenix, Arizona
5231 Central Ave. West, Albuquerque,
New Mexico

Heidelberg Pacific, Inc.
Dealer for Heidelberg Automatic Presses
464 Clementina Street, San Francisco 3,
California
1606 N.W. 23rd Avenue, Portland 10, Oregon
1928 9th Avenue, Seattle 1, Washington

Heidelberg Central, Inc.
Dealer for Heidelberg Automatic Presses
800 East 10th Street, Kansas City 6, Missouri
529 South Seventh Street, Minneapolis 15,
Minnesota

Heidelberg Southern Sales Company
1847 Cheshire Bridge Road N.E., Atlanta 9,
Georgia